



••••
BIOPROCESS
equipment & supplies



2024



CONTENTS

Bioreactor Replacement Parts and Accessories

Like-for-Like Replacement Parts for Applikon® Biotechnology and Broadley-James® brand Bioreactors

Glass Vessels, Stands & Accessories.....	3-4
Agitator Assemblies	5
Headplates and Assembly Stand	6
Impellers	7
Port Adapters	8-9
Level Sensor Adapter.....	10
Aeration Tubes.....	10
Thermowells.....	10
Air Inlet / Outlet Adapters	11
Blind Stoppers.....	11
Adjustable Sampling Tubes	11
Sampling Tubes and Diptube.....	12
Heat Exchangers	13
Addition Pipes	13
Baffle Assemblies.....	14
Aeration Tubes.....	14
Harvest Tubes.....	14
Probe and Septum Holders.....	15

Bioreactor Accessories

DO and pH Probes and Accessories	16-18
Heating Blankets.....	19
Transfer Media Bottles	19
Vent Port Assemblies for Transfer Bottles.....	20
Condensers.....	20
Bioreactor Stirrer Motor.....	21
Replacement O-Rings.....	21
Cable Tie Gun and Cable Ties	22
Luer Lock Adapters	22
Genesis Tube Sealers.....	23
Versilic™ Peroxide-Cured Silicone Tubing	23

Bioprocess Equipment and Supplies

CHEMcell Rocker and Accessories	24-25
Single-Use Bottle Assemblies	26-27
Sample Tubes	27
Transfer Vessels	28-29
Tubing Clamps	28
Pressure Relief Check Valves.....	28
Erlenmeyer Culture Flasks.....	30-34
Multi-Function Liquid Transfer Caps	30-31
Biofactories	35
BelloCell Cell Culture Systems	36-37
GlucCell Glucose Monitoring System	38
Spinner Flasks	39
Bioreactor Vessels	40
Bioreactor Overhead Motor & Accessories ...	41-42
Bioreactor Port Assemblies.....	42-44
Bioreactor / Spinner Flask Heating Blankets	44
Bioreactor DO & pH Probes.....	45-46
Probe Holders	46
Versa-Orb Shaker Rack / 50mL Tubes	47
N-Biotek Multi-Function Incubators.....	48
Media Storage Bottles.....	49
Versa-Orb Digital Orbital Shaker.....	49
Media Storage Bottle Caps / Pour Rings	49-51
Bioreactor Port Assemblies.....	52
Media Bottles with Siphon Assembly	52
High Volume Digital Magnetic Stirrers	53
Stackable Incubator Shakers	54-55

High Volume Stirrers

See page 53.



Chemglass Life Sciences is pleased to announce the availability of like-for-like, replacement components for the popular 2, 3, 5, 7 and 15 liter sizes of Applikon® and Broadley-James® bioreactors. All stainless steel components are manufactured from 316L stainless with an electropolished surface finish of 20Ra or better. Borosilicate glass vessels include jacketed, unjacketed and red stained versions. **Contact us if you require any parts not shown here.**

Unjacketed Glass Bioreactor Vessels

Vessels are constructed of heavy wall tubing and are graduated in 200mL subdivisions with numbers every 1000mL.

Unjacketed Glass Bioreactor Vessels

Part Number	Vessel Cap. (L)	Vessel Min. Working Volume (L)	Vessel I.D. (mm)	Overall Height (mm)	Price
CLS-1379-01	2	0.5	105	246	\$621.40 ♥
CLS-1380-01	3	0.5	130	260	\$1,028.10 ♥
CLS-1382-01	5	1.0	160	260	\$1,058.70 ♥
CLS-1383-01	7	2	160	360	\$1,116.40 ♥
CLS-1385-01	15	2.5	222	446	\$2,629.30 ♥



CLS-1380-01



CLS-1380-STD3
CLS-1382-STD5
CLS-1383-STD7
CLS-1383-STD15

Tripod Stand For Unjacketed Vessels

Stand to hold unjacketed bioreaction vessels. Top, two-piece ring is made of anodized aluminum while the lower ring and legs are electropolished stainless steel. Stands come complete with silicone o-ring and six, knurled nuts to attach the headplate to the stand.

Tripod Stands for Unjacketed Vessels

Part Number	Vessel Cap. (L)	Replacement Silicone O-Ring	Price
CLS-1380-STD3	2-3	CLS-1705-150X4	\$836.20 ♥
CLS-1382-STD5	5	CLS-1705-177X4	\$866.90 ♥
CLS-1383-STD7	7	CLS-1705-177X4	\$890.00 ♥
CLS-1385-STD15	15	CLS-1705-274	\$1,473.00 ♥

See Replacement Rubber Feet and Accessory Stabilizer Bars for Tripod Stands on the next page.



CHEMcell Rocker and Accessories

See pages 24-25.



CLS-1381-01

Jacketed Glass Bioreactor Vessels

Jacketed vessels are constructed of heavy wall tubing and are graduated in 200mL subdivisions with numbers every 1000mL. Connections to circulator are GL-18 glass threads and are supplied complete with caps and plastic hose connections. **15L jacketed vessels available - please contact us.**

Jacketed Glass Bioreactor Vessels

Part Number	Vessel Cap. (L)	Vessel Min. Working Volume (L)	Vessel I.D. (mm)	Overall Height (mm)	Price
CLS-1381-01	3	0.5	130	275	\$1,531.30 ♥
CLS-1382-30	5	1.0	160	275	\$2,073.30 ♥
CLS-1384-01	7	2	160	375	\$2,312.50 ♥

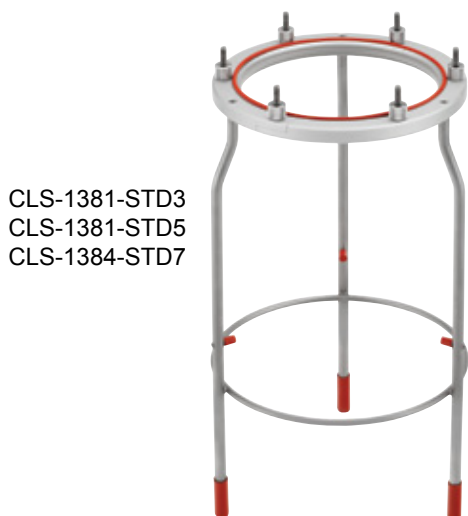

CLS-1381-STD3
CLS-1381-STD5
CLS-1384-STD7

Tripod Stand For Jacketed Glass Bioreactor Vessels

Stand for jacketed bioreaction vessels. Top, two-piece ring is made of anodized aluminum. The lower ring and legs are electropolished stainless steel. Stands come complete with silicone o-ring and six, knurled nuts to attach the headplate to the stand. **Stands for 15L jacketed vessels available - please contact us.**

Tripod Stands for Jacketed Glass Bioreactor Vessels

Part Number	Vessel Cap. (L)	Replacement Silicone O-Ring	Price
CLS-1381-STD3	2-3	CLS-1705-150X4	\$1,089.30 ♥
CLS-1386-STD5	5	CLS-1705-177X4	\$1,135.40 ♥
CLS-1384-STD7	7	CLS-1705-177X4	\$1,181.50 ♥

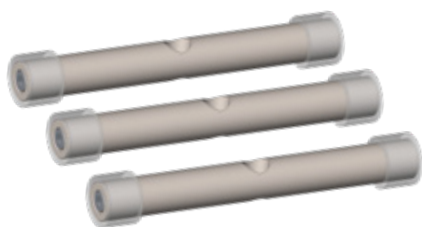

CLS-1385-SBD3

Stabilizer Bars For 15L Stands, Set Of Three

Six-inch long bar attaches to legs of 15 liter stands and adds an additional measure of safety to the 15 liter bioreactor. Sold as a set of three.

Stabilizer Bars for 15L Stands

Part Number	Description	Price
CLS-1385-SBD3	Set of Three, for 15L Stands	\$308.40 ♥

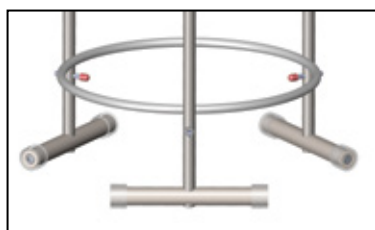

Stabilizer bars shown installed on a bioreactor stand.

Replacement Silicone Feet For Tripod Stands

Replacement silicone feet for 3, 5 and 7 liter bioreactor, tripod stands. Sold as a pack of 12.

Replacement Silicone Feet for Tripod Stands

Part Number	Description	Price
CLS-1380-084	For 3, 5 and 7 Liter Tripod Stands	\$14.00 ♥



CLS-1380-084 Pack of 12

DISCOUNT KEY: * Not Subject to Discount. † Reusable Glass. ♣ Celltreat / Consumable LM Products.

Agitator Assemblies

Agitator assembly is constructed of 316L stainless steel and screws into the M30 thread in the center of the headplate. Design ensures contamination-free sealing around the shaft. CLS-1385-05 attaches to the headplate with 4 bolts. CLS-1385-35 requires adapter plate, CLS-1385-30, for use in a 15L reactor.

Agitator Assemblies

Part Number	Vessel Cap. (L)	Replacement Silicone O-ring	Length of Shaft Through Headplate (mm)	Shaft Dia. (mm)	Price
CLS-1380-05	2-5	CLS-1705-124	222	8	\$1,311.80 ♥
CLS-1383-04	7	CLS-1705-124	300	8	\$1,373.20 ♥
CLS-1385-05	15	CLS-1705-131	392	15	\$2,907.60 ♥
CLS-1385-35	15	CLS-1705-131	390	8	\$1,406.50 ♥



CLS-1380-05
CLS-1383-04
CLS-1385-05
CLS-1385-35

Rebuild Kits For Agitator Assemblies

Kits of o-rings, seals and bearings to rebuild agitator assemblies.

Headplates

Part Number	Fits Agitator	Shaft Size (mm)	Price
CLS-1380-05PM	CLS-1380-05 CLS-1383-04 CLS-1385-35	8	\$135.00 ♥
CLS-1385-05PM	CLS-1385-05	15	\$212.80 ♥

Applikon Agitator to Sartorius Motor Adapter Kit

Adapter kit converts our standard “Applikon-style” agitator assembly to fit a Sartorius motor. **NOTE:** This is the adapter kit only and does not include the agitator assembly.

Applikon Agitator to Sartorius Motor Adapter

Part Number	Description	Price
CLS-1380-SAR1	Sartorius Motor Adapter Kit	\$440.90 ♥



CLS-1380-SAR1

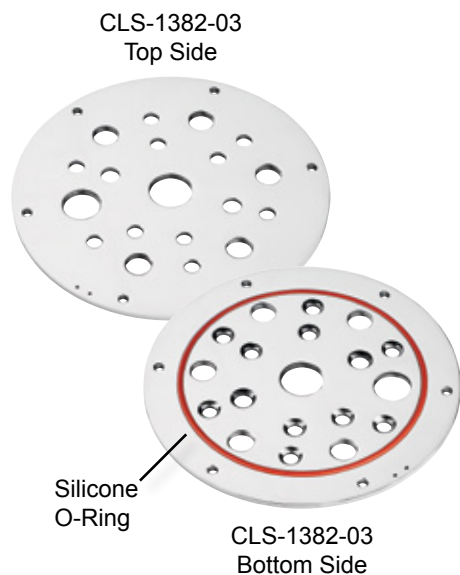

CLS-1385-30
Top Side



CLS-1385-30
Bottom Side

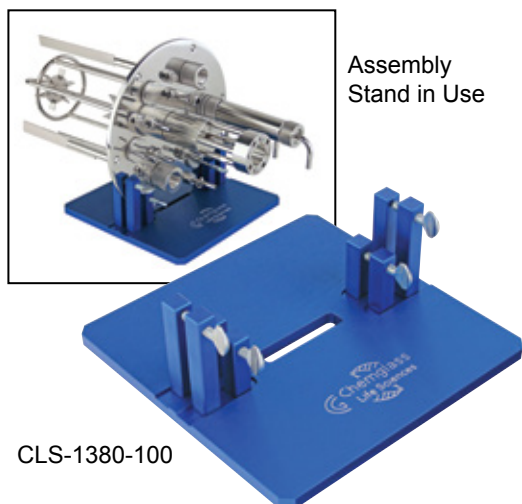

Headplates

Headplate is constructed of 316L stainless steel and electropolished to a mirror finish. Supplied complete with a silicone o-ring that mates to the glass vessel. Number and size of ports as listed.

Headplates

Part Number	Vessel Cap. (L)	Replacement Silicone O-Ring		Price
CLS-1379-02	2	CLS-1705-135X4		\$953.00 ♥
16 Total Ports	M30 Center 6 each M10	1 each G-3/4 3 each M6	5 each M18	
CLS-1380-03	3	CLS-1705-135X4		\$997.30 ♥
18 Total Ports	M30 Center 2 each M12	1 each G-3/4 6 each M10	5 each M18 3 each M6	
CLS-1382-03	5 and 7	CLS-1705-260		\$1,196.80 ♥
19 Total Ports	M30 Center 2 each M12	1 each G-3/4 10 each M10	5 each M18	
CLS-1385-03	15	CLS-1705-373		\$3,605.60 ♥
19 Total Ports	69mm Center Port for Agitator 6 each M27	2 each M12	10 each M10	

Adapter Plate, 15L Bioreactor To M30

For conversion of the 15 liter headplate, CLS-1385-03, from a 69mm opening to an M30 thread, thereby accepting the CLS-1385-35 agitator assembly.

Adapter Plate for 15L Headplates

Part Number	Description	Price
CLS-1385-30	Adapter Plate, M30	\$466.30 ♥

Headplate Assembly Stand

Constructed of blue anodized aluminum, stand permits easy assembly of components into headplates. Will fit from 2 to 15 liter headplates, which are secured with four nylon-tipped thumb screws. Plate is eight inches wide by eight inches deep. Distance between uprights is 8mm.

Headplate Assembly Stand

Part Number	Description	Price
CLS-1380-100	Headplate Assembly Stand	\$568.50 ♥

DISCOUNT KEY: * Not Subject to Discount. † Reusable Glass. ♣ Celltreat / Consumable LM Products.

Marine Style Impeller Blades

Marine style impeller blades are available in two styles, vortexing and scoping. The 2 through 7 liter sizes fit the 8mm shaft of the agitator assembly. The 15 liter has an option of either the 8mm or the 15mm shaft size. These blades are used primarily for mammalian cell culture work.

Marine Style Impeller Blades, Scoping and Vortexing

Part Number	Impeller Type	Fits Reactor (L)	Fits Shaft Size (mm)	Impeller Dia. (mm)	Price
CLS-1380-06	Vortex (Down)	2-3	8	43	\$530.80 ♥
CLS-1380-07	Scoping (Up)	2-3	8	43	\$530.80 ♥
CLS-1382-05	Vortex (Down)	5-7	8	59	\$675.95 ♥
CLS-1382-06	Scoping (Up)	5-7	8	59	\$649.95 ♥
CLS-1385-06	Vortex (Down)	15	15	76	\$713.45 ♥
CLS-1385-07	Scoping (Up)	15	15	76	\$713.45 ♥
CLS-1385-36	Vortex (Down)	15	8	76	\$809.85 ♥
CLS-1385-37	Scoping (Up)	15	8	76	\$825.25 ♥



CLS-1382-06



CLS-1382-05

Rushton Style Impeller Blades

The 3 through 7 liter sizes fit the 8mm Shaft, while the 15 liter fits the 15mm shaft. These blades are used primarily for bacterial cell culture work.

Rushton Style Impeller Blades

Part Number	Fits Reactor (L)	Impeller Diameter (mm)	Fits Shaft Size (mm)	Price
CLS-1380-08	2-3	48	8	\$433.40 ♥
CLS-1382-07	5-7	60	8	\$460.50 ♥
CLS-1385-20	15	76	15	\$528.15 ♥
CLS-1385-50	15	76	8	\$790.10 ♥



CLS-1382-07



CLS-1380-57



CLS-1380-09

Double Port Adapter, M18

Double port adapter fits into a headplate and has two, 4mm OD, connections to fit precision tubing size 16. Inside the reactor, the 4mm tubes are 1.25" long.

Double Port Adapter

Part Number	Thread Size	Replacement Silicone O-Ring	Price
CLS-1380-57	M18	CLS-1705-20x2	\$287.80 ♥

Triple Port Adapters, M18 And M27

Triple inlet adapter fits into a headplate and incorporates three separate pipes in one assembly for efficient use of space. The adapter has three, 1/8" (3.2mm) tubing ports for connection to flexible tubing and can be used individually for reagent addition. Inside the reactor, the 1/8" tubes are 3/4", 1" and 1 1/8" long.

Triple Port Adapter

Part Number	Thread Size	Replacement Silicone O-Ring	Price
CLS-1380-09	M18	CLS-1705-20X2	\$322.20 ♥
CLS-1385-08	M27	CLS-1705-121	\$560.10 ♥

Now available at Chemglass Life Sciences



Stack Up to 3 High

Large Capacity & Compact CO2 Incubator Shakers

CLS-2545-series Stackable Large Capacity
CLS-2542-series Stackable Compact

See pages 54 and 55 for more information on CO2 Incubator Shakers

DISCOUNT KEY: * Not Subject to Discount. † Reusable Glass. ♣ Celltreat / Consumable LM Products.

Triple Port Adapter, M10

316L stainless steel triple port assembly fits into a 10mm head port plate. The assembly incorporates three separate pipes into one assembly for efficient use of space. Each port can be used individually for reagent addition. M10 threaded adapter has (3) 1/8" OD tubing ports for connection to flexible tubing. Inside the reactor the tubes are 7mm long; above the headplate they are 1.59", 2.09", and 2.59" long. Electropolished to Ra20 or better.

Triple Port Adapter, 1/8" OD Tubing

Part Number	Thread Size	Replacement Silicone O-Ring	Price
CLS-1380-323	M10		\$704.70 ♥

Quad Port Adapters, M18

Quad inlet assembly fits an 18mm head plate port and incorporates four separate pipes in one assembly for efficient use of space. Each port can be used individually for reagent addition. M18 threaded adapter has (4) 1/8" (3.2mm) tubing ports for connection to flexible tubing. Inside the reactor, the 1/8" tubes are 5/8", 3/4", 1" and 1-1/8" long.

Quad Port Adapter

Part Number	Thread Size	Replacement Silicone O-Ring	Price
CLS-1380-409	M18	CLS-1705-20X2	\$382.50 ♥

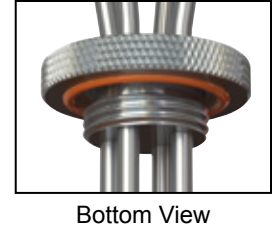
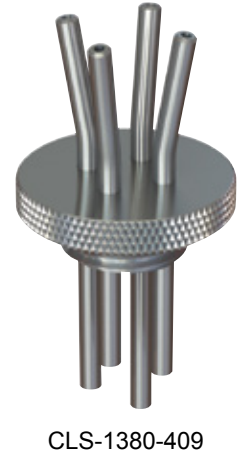



CLS-1380-92

Level Sensor Adapter

Used to install a 1/4" OD (6.35mm) level sensor into an M10 headplate port.

Level Sensor Adapter

Part Number	Thread Size	Price
CLS-1380-92	M10	\$186.10 ♥

Aeration Tube With Porous Sparger, M10

The 15µm, sintered metal tip produces tiny air bubbles for optimum gas distribution. The "A" dimension listed allows for placement in different ports of the headplate. **NOTE:** Replacement o-ring listed is for M10 connection.

Aeration Tubes with Porous Spargers

Part Number	Fits Reactor (L)	Immersion	Dim. "A" (mm)	Replacement Silicone O-Ring	Price
CLS-1379-04	2	236	48	CLS-1705-85X25	\$590.60 ♥
CLS-1380-12	3	238	50	CLS-1705-85X25	\$644.40 ♥
CLS-1382-08	5	238	73	CLS-1705-85X25	\$698.10 ♥
CLS-1383-06	7	330	73	CLS-1705-85X25	\$751.90 ♥
CLS-1385-11	15	420	93	CLS-1705-85X25	\$828.50 ♥

Replacement Sparger Tips

Part Number	Porosity (µm)	Replacement Silicone O-Ring	Price
CLS-1380-14	10	CLS-1705-007	\$214.80 ♥
CLS-1380-15	15	CLS-1705-007	\$214.80 ♥
CLS-1380-16	50	CLS-1705-007	\$214.80 ♥
CLS-1380-17	100	CLS-1705-007	\$225.50 ♥

Thermowell, M10

M10 threaded thermowell having an I.D. of 0.310" that will accept 1/4" thermocouple probes. To enhance temperature measurement, the thermowell should be partially filled with a heat conducting silicone or mineral oil.

Thermowells

Part Number	Fits Reactor (L)	Immersion Length (mm)	Replacement Silicone O-Ring	Price
CLS-1380-11	2-5	200	CLS-1705-85X25	\$184.10 ♥
CLS-1383-05	7	300	CLS-1705-85X25	\$214.80 ♥
CLS-1385-10	15	370	CLS-1705-85X25	\$306.80 ♥



CLS-1382-08

CLS-1380-11

DISCOUNT KEY: * Not Subject to Discount. † Reusable Glass. ♣ Celltreat / Consumable LM Products.

Air Inlet / Outlet Adapter

Adapter can be used as a gas outlet pipe in lieu of a condenser in applications where the aeration rate or temperature is low or for short term batch application. More often, this pipe is used to provide overlay aeration.

Air Inlet / Outlet Adapters

Part Number	Thread Size	Hose Conn. O.D. (mm)	Fits Tubing Size	Replacement Silicone O-Ring	Price
CLS-1380-55	M6	4.00	16	CLS-1705-010	\$151.40 ♥
CLS-1380-20	M10	6.35	17	CLS-1705-85X25	\$168.70 ♥
CLS-1380-18	M18	12.00	73	CLS-1705-20X2	\$183.40 ♥
CLS-1385-27	M27	12.00	73	CLS-1705-121	\$248.00 ♥



CLS-1380-55



CLS-1380-20

Blind Stoppers

Stoppers can be used to close off any of the unused openings in the headplate. The M6, M10 and M12 sizes are fitted into the headplate from the inside, leaving a flat surface. The M18, M27 and G-3/4 are threaded into ports from the outside.

Blind Stoppers

Part Number	Size	Replacement Silicone O-Ring	Price
CLS-1380-22	M6	CLS-1705-010	\$63.00 ♥
CLS-1380-23	M10	CLS-1705-85X25	\$69.10 ♥
CLS-1380-24	M12	CLS-1705-111	\$75.20 ♥
CLS-1380-25	M18	CLS-1705-20X2	\$113.60 ♥
CLS-1385-14	M27	CLS-1705-121	\$140.50 ♥
CLS-1380-26	G-3/4	CLS-1705-023	\$150.50 ♥
CLS-1380-80	M30	CLS-1705-026	\$157.40 ♥

 CLS-1380-22
 CLS-1380-23
 CLS-1380-24

Top View

 CLS-1380-25
 CLS-1385-14
 CLS-1380-26
 CLS-1380-80

Bottom View



CLS-1383-08

Sampling Tube, Adjustable, M10

This sampling tube is adjustable to permit the culture fluid to be sampled at any desired level. Tubing is 1/4" OD.

Adjustable Sampling Tubes

Part Number	Fits Reactor (L)	Maximum Immersion Length (mm)	Replacement Silicone O-Ring	Price
CLS-1380-21	2-5	232	CLS-1705-85X25	\$214.80 ♥
CLS-1383-08	7	325	CLS-1705-85X25	\$225.60 ♥
CLS-1385-13	15	390	CLS-1705-85X25	\$380.70 ♥

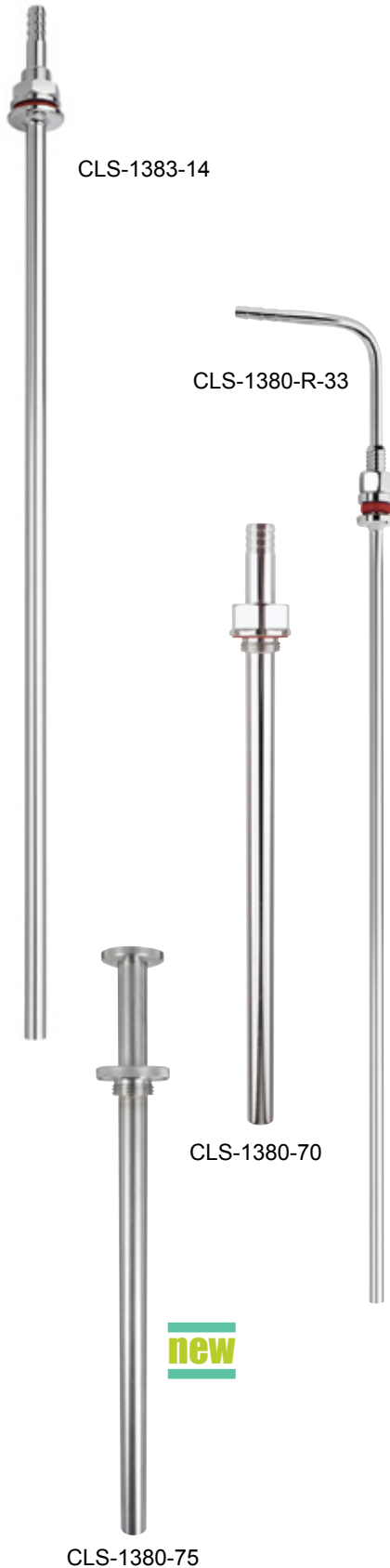

Sampling Tube, Fixed, M10

Fixed height sampling tubes for bioreactors. Tubing is 1/4" OD.

Fixed Height, Sampling Tubes

Part Number	Fits Reactor (L)	Maximum Immersion Length (mm)	Replacement Silicone O-Ring	Price
CLS-1380-33	2-5	212	CLS-1705-85X25	\$167.30 ♥
CLS-1383-14	7	315	CLS-1705-85X25	\$176.40 ♥
CLS-1385-26	15	400	CLS-1705-85X25	\$303.90 ♥

Sampling Tube, Reduced Diameter Fixed, M6

Sampling tube with a reduced diameter which requires a smaller amount of sample to be drawn from the reactor. Tubing is 1/8" OD.

Reduced Diameter, Sampling Tubes

Part Number	Fits Reactor (L)	Maximum Immersion Length (mm)	Replacement Silicone O-Ring	Price
CLS-1380-R-33	2-5	210	CLS-1705-010	\$161.20 ♥

Sampling Pipe / Harvest Tube, Large Diameter, M18

Pipe will fit a 2 to 5 liter reactor and has a lower diameter of 1/2" and a length of 212mm into the reactor. The serrated hose connection is also 1/2" (12.7mm) OD. Can also be used as a quick way to harvest material due to its size.

Large Diameter, Sampling Pipe / Harvest Tube

Part Number	Thread Size	Replacement Silicone O-Ring	Price
CLS-1380-70	M18	CLS-1705-20x2	\$207.60 ♥

Diptube Assembly, 1/2" Sanitary, M18, Stainless Steel

316L stainless steel diptube assembly with 1/2" sanitary fitting on top and fits into an 18mm head port plate. The length inside the bioreactor is 7.66". The overall length is 9.87". Electropolished Ra20 or better.

Diptube Assembly, 1/2" Sanitary

Part Number	Thread Size	Immersion Length (in)	Price
CLS-1380-75	M18 x 1.5	7.66	\$383.90 ♥

DISCOUNT KEY: * Not Subject to Discount. † Reusable Glass. ♣ Celltreat / Consumable LM Products.

Heat Exchangers

Heat exchangers are available in a choice of two different styles. The cold finger style is for use with 2 - 5 liter reactors and fits into the headplate via an M18 threaded port. The second style is a loop type exchanger and is available for 5 - 15 liter reactors. It fits into two, M10 ports of the headplate.

Heat Exchangers, Cold Finger and Loop Styles

Part Number	Fits Reactor (L)	Exchanger Style	Replacement Silicone O-Ring	Price
CLS-1380-28	2-5	Cold Finger	CLS-1705-20X2	\$537.00 ♥
CLS-1382-11	5	Loop	CLS-1705-85X25	\$1,347.00 ♥
CLS-1383-12	7	Loop	CLS-1705-85X25	\$1,380.80 ♥
CLS-1385-16	15	Loop	CLS-1705-85X25	\$1,895.80 ♥

Addition Pipes

This adapter can be used to add fluids or gases to the bioreactor.

Addition Pipe Adapter

Part Number	Fits Reactor (L)	Thread Size	Replacement Silicone O-Ring	Price
CLS-1380-31	2-7	M10	CLS-1705-85X25	\$161.20 ♥
CLS-1380-40	3-15	M12	CLS-1705-111	\$264.70 ♥
CLS-1380-51	2-7	M18	CLS-1705-20X2	\$278.30 ♥



CLS-1380-28

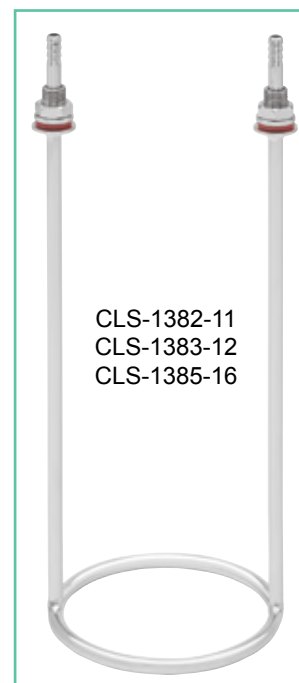

CLS-1382-11
CLS-1383-12
CLS-1385-16



CLS-1380-31

Custom component? We can do it . . . Call 1.800.843.1794 today.



Whether it's a slight modification to a standard part or a completely new component, our skilled engineering and production teams are glad to partner with you to meet your product expectations.

We've been providing quality CNC machining services as well as bending, welding and electropolishing to science professionals for decades.

Chemglass Life Sciences' experienced technical service representatives are ready to discuss your requirements. Get in touch today.

Baffle Assemblies

Baffles are used to increase the mixing efficiency inside the bioreactor and are mounted near the reactor wall for optimum mixing performance.

Baffle Assemblies

Part Number	Fits Reactor (L)	Thread Size	Replacement Silicone O-Ring	Price
CLS-1381-04	2-3	M6	CLS-1705-010	\$233.20 ♥
CLS-1382-10	5	M10	CLS-1705-85X25	\$263.90 ♥
CLS-1383-11	7	M10	CLS-1705-85X25	\$283.90 ♥
CLS-1385-17	15	M10	CLS-1705-85X25	\$429.60 ♥

Air Aeration Tubes, M10

This tube is to be used when high gas flow rates are required. The sparger pipe extends to the bottom of the vessel and terminates just below the impellers on the stirrer shaft. This allows bubbles coming out of the sparger to rise up into the impellers where they are broken up for improved oxygen transfer.

Aeration Tubes

Part Number	Fits Reactor (L)	Length of Tube Below the Headplate (mm)	Replacement Silicone O-Ring	Price
CLS-1379-06	2	226	CLS-1705-85X25	\$291.60 ♥
CLS-1381-05	3-5	238	CLS-1705-85X25	\$314.60 ♥
CLS-1384-06	7	330	CLS-1705-85X25	\$421.90 ♥
CLS-1385-18	15	420	CLS-1705-85X25	\$813.10 ♥

Harvest Tubes, M10 And M27

Mounts into the outer M10 thread on standard headplates. Tapered tip extends to within 2mm of the vessel bottom to allow complete harvesting of cells. The 15 liter size has an M27 thread with 1/2" tubing for quicker harvest.

Harvest Tubes

Part Number	Vessel Capacity (L)	Replacement Silicone O-Ring	Price
CLS-1380-32	3	CLS-1705-85X25	\$168.70 ♥
CLS-1382-12	5	CLS-1705-85X25	\$184.10 ♥
CLS-1383-13	7	CLS-1705-85X25	\$237.80 ♥
CLS-1385-23	15	CLS-1705-121	\$429.60 ♥



DISCOUNT KEY: * Not Subject to Discount. † Reusable Glass. ♣ Celltreat / Consumable LM Products.

Probe Holder, 12mm, Fixed Height

Probe holder for 12mm probes. These are non-height adjustable.

Fixed Height, Probe Holder

Part Number	Thread Size	Replacement Silicone O-Ring		Price
		Interior	Exterior	
CLS-1381-08	M18	CLS-1705-111	CLS-1705-20X2	\$196.40 ♥
CLS-1381-09	G-3/4	CLS-1705-111	CLS-1705-023	\$202.50 ♥
CLS-1385-21	M27	CLS-1705-111	CLS-1705-121	\$368.10 ♥



CLS-1381-08

Probe Holder, 12mm, Adjustable Height

Probe holder for 12mm probes. Height adjustable with compression fitting.

Adjustable Height, Probe Holder

Part Number	Thread Size	Replacement Silicone O-Ring	Price
CLS-1381-06	M18	CLS-1705-20X2	\$276.20 ♥
CLS-1381-07	G-3/4	CLS-1705-023	\$299.20 ♥
CLS-1385-19	M27	CLS-1705-121	\$414.40 ♥



CLS-1381-06

Replacement FKM Compression Ring for 12mm Probe

Part Number	Description	Pkg. Qty.	Price
1380-027	FKM Compression Ring	1	\$7.50 ♥

Probe Holder, 19mm, Adjustable Height

Probe holder for 19mm probes. Height adjustable with compression fitting.

Adjustable Height, Probe Holder

Part Number	Thread Size	Replacement Silicone O-Ring	Price
CLS-1381-10	G-3/4	CLS-1705-023	\$337.50 ♥
CLS-1385-22	M27	CLS-1705-121	\$414.40 ♥



CLS-1381-10

Replacement FKM Compression Ring for 19mm Probe

Part Number	Description	Pkg. Qty.	Price
1381-009	FKM Compression Ring	1	\$8.90 ♥

Septum Holder, M18 and M27

The septum holder is supplied with a silicone rubber septum and can be used as a universal addition port for fluid or gas. Replacement septa are available.

Septum Holder

Part Number	Thread Size	Replacement Silicone O-Ring	Price
CLS-1380-10	M18	CLS-1705-20X2	\$273.20 ♥
CLS-1385-09	M27	CLS-1705-121	\$414.40 ♥



CLS-1380-10

Replacement Septa

Part Number	Description	Pkg. Qty.	Price
CLS-1380-014	Silicone Rubber Septum	10	\$14.60 ♥

♥ Bioreactor Reactor Discount. ■ Spinner Flasks and Accessories. ◇ Life Sciences Consumables.



DO Probe Standard
4 Pole T82/D4
Connector



DO Probe with
VP Connector

Hamilton DO Probes To Fit Bioreactors

The OxyFerm FDA is an electrochemical oxygen sensor suited for applications with high demands for hygiene, e.g. in pharmaceutical industry, in biotechnology and in foods and beverages production. When using Oxylyte USD electrolyte, even upside-down insertion is possible. The sensor is equipped with a FDA approved membrane for usage in hygienic processes.

Specifications

Electrode System	Silver Platinum Combination
Polarization	670mV ± 50mV
Output	40 to 80nA in Air at 25°C
Temperature	0-130°C, Sterilization to 130°C
Drift at Room Temp Under Constant Conditions	<1% per Week
Stabilization Time	<2 Hours
Pressure	0-4 Bar
Wetted Materials	Stainless Steel 1.4435, EPDM and Silicone with FDA Approval
Mounting	PG 13.5 Thread
Electrical Connector	Standard 4 Pole T 82/D4

DO Probes Standard 4 Pole T82 / D4 Connectors

Part Number	Fit Reactor (L)	Probe O.D. (mm)	Probe Length (mm)	Price
CLS-1435-D72	2-5 Liter	12	235	Call *
CLS-1435-D73	7 Liter	12	320	Call *
CLS-1435-D74	15 Liter	12	420	Call *

DO Probes with VP Connectors

Part Number	Fit Reactor (L)	Probe O.D. (mm)	Probe Length (mm)	Price
CLS-1435-D82	2-5 Liter	12	235	Call *
CLS-1435-D83	7 Liter	12	325	Call *
CLS-1435-D84	15 Liter	12	425	Call *

Accessories

Part Number	Description	Price
CLS-1435-D88	OxyFerm Membrane Kit	Call *
CLS-1435-D90	Cathode Assembly for OxyFerm DO Sensors	Call *
CLS-1435-D91	Electrolyte for OxyFerm FDA Sensors, 50mL	Call *
CLS-1435-D92	Protective Cap for T82 DO Sensor Autoclaving	Call *

DISCOUNT KEY: * Not Subject to Discount. † Reusable Glass. ♣ Celltreat / Consumable LM Products.

Hamilton pH Probes

The EasyFerm Plus K8 sensors are designed to withstand demanding applications in pharmaceutical and chemical industries. The EVEREF-F reference cartridge ensures that the phermlyte reference electrolyte remains free of silver and precipitation. The EasyFerm Plus K8 is supplied with a pre-sterilized electrolyte which prevents the diffusion of sample into the sensors. It withstands steam sterilization, autoclaving, CIP, organic solvents and strong acids. Fully autoclavable or in-situ sterilizable.

Specifications

pH Range	0-14
Electrolyte	Pressurized phermlyte
Pressure Range	0-6 Bar
Electrical Connector	Type K8 - Standard pH Connector Head or VP
Reference System	HAMILTON EVEREF-F, Silver ion barrier included
Temperature Range	Steam Sterilizable/Autoclavable to 266°F (0 to 135°C)
In-situ Sterilization	Up to 100 Cycles under Standard Conditions

pH Probes Standard K8 Connectors

Part Number	Fit Reactor (L)	Probe O.D. (mm)	Probe Length (mm)	Price
CLS-1435-P72	2-5	12	225	Call *
CLS-1435-P73	7	12	325	Call *
CLS-1435-P74	15	12	425	Call *

pH Probes with VP Connectors

Part Number	Fit Reactor (L)	Probe O.D. (mm)	Probe Length (mm)	Price
CLS-1435-P77	2-5	12	225	Call *
CLS-1435-P78	7	12	325	Call *
CLS-1435-P79	15	12	425	Call *

pH and DO Probe Rack

Freestanding rack can hold 36 probes (pH or DO) up to 235mm long. Rack is constructed of polypropylene with stainless steel uprights.

Racks available for longer probes - contact us: tech@cglifesciences.com.

Probe Rack

Part Number	Description	Price
CLS-1455-R1	pH and DO Probe Rack	\$180.60 ♥



CLS-1435-P-series



CLS-1455-R1
Probes sold separately.



CLS-1434-series



Blue light: A decisive part of the VISIFERM™ measurement principle.

Hamilton VisiFerm Optical DO Probes

The VisiFerm DO is the first optical oxygen sensor with integrated opto-electronics, having the full functionality of a measuring device with self-diagnostics. It is steam sterilizable, autoclavable and CIP compatible. The VisiFerm requires less maintenance than a classical oxygen sensor as it does not have a mechanically sensitive membrane or a corrosive electrolyte.

Advantages of Optical Measurement

- More accurate measurement because optical sensors do not consume oxygen
- Without electrolyte the sensor reading is not affected by mounting orientation
- Quicker response time results in less wasted product
- Improved mechanical and measurement stability with a glass window
- Signal is not influenced by electrostatics and mechanical stress
- No impact on measurement or sensor life due to H₂S fouling

Specifications

Measuring Principle	Oxygen dependent luminescence Quenching
Measuring Range	4ppm to 25ppm
Response Time	< 30 seconds at 25°C
Autoclavable	Yes
Steam Sterilizable	Yes (Max 140°C)
Pressure Range	-1 to 12 Bar
Probe Diameter	12mm
Connection to Process	PG 13.5 Thread
Electrical Connection	VP8
Wetted Materials	SS 1.4435, Silicone EPDM

Optical DO Probes

Part Number	Fit Reactor (L)	Probe Length (mm)	Price
CLS-1434-60	1-5	225	Call *
CLS-1434-62	7	325	Call *
CLS-1434-64	15	425	Call *



CLS-1435-BTL

Probe Holders, Soaker Bottles, pH Electrode or DO Probes

The cap and o-ring compresses and securely seals against the electrode body, sealing the solution from the atmosphere to minimize evaporation, prevent spillage and increase solution life. Probe holder bottles should be filled with water for DO probe storage or KCl solution for pH electrode storage. Available in a pack of 4.

Probe Holder / Soaker Bottles

Part Number	Description	Pkg. Qty.	Price
CLS-1435-BTL	Probe Holder / Soaker Bottle	4	\$35.10 *

DISCOUNT KEY: * Not Subject to Discount. † Reusable Glass. ♣ Celltreat / Consumable LM Products.

Heating Blankets, 110V with Velcro®

Manufactured to fit snugly around Applikon®-style, unjacketed vessels to supply uniform heat. Made of silicone rubber, all sizes are 110VAC with the wattage as listed. Velcro allows easy installation, even with the vessel in a support stand. Plugs are IEC standard 2-prong.

Heating Blankets with Velcro

Part Number	Fits Reactor (L)	Wattage	Dimensions W x L (in.)	Price
CLS-1379-08V	2	110	5 x 16	\$374.85 ♥
CLS-1380-19V	3	110	3.5 x 19	\$461.15 ♥
CLS-1383-07V	5-7	178	3 x 23	\$525.15 ♥
CLS-1385-12V	15	383	4 x 32	\$787.05 ♥
CLS-1385-1210V	15	383	10 x 32	\$907.65 ♥



Heating Blanket

Adapter, Plug, 3-Prong, Molded

- NEMA 5-15R to IEC 60320-C14 Plug Adapter
- Rated up to 10A 125V
- Fully molded rugged construction
- For use with Finesse® controllers

CAUTION: This plug adapter does NOT transform voltage. Verify your device or power supply is within the output range before use or damage will occur.

Finesse® is a registered trademark of Finesse Solutions, Inc.

Molded Adapter Plug

Part Number	Description	Price
CG-3211-11	Plug Adapter, 3-Prong NEMA 5-15R to IEC 60320-C14	\$14.50 ♥



CG-3211-11

Opposite End

Transfer Media Bottles, Clear, with Hose Barbs and GL-45 Vented Caps

For easy gravity transfer of solutions. Schott bottle with drip-free pouring ring and liner-less, one piece, autoclavable, reusable, vented cap. Hose barb outlet at the bottom allows for easy gravity transfer of solutions. The hose barb accepts the ID tubing listed.

Transfer Media Bottles with Vented Caps

Part Number	Vessel Cap. (mL)	Tubing Size for Hose Barb	Price
CLS-1423-100	100	1/4"	\$55.40 ■
CLS-1423-250	250	1/4"	\$67.70 ■
CLS-1423-500	500	1/4"	\$75.90 ■
CLS-1423-1L	1000	1/4"	\$133.40 ■
CLS-1423-2L	2000	1/4"	\$244.60 ■
CLS-1423-5L	5000	1/4"	\$474.50 ■
CLS-1423-10L	10,000	1/2"	\$755.90 ■



CLS-1423-series

Other size hose barbs available, please contact us for details.

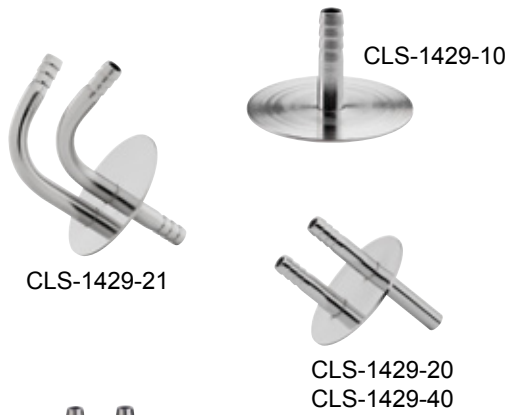

Vent Port Assemblies For Transfer Bottles

Vent port assemblies constructed of 316 stainless steel and electropolished to a 20Ra or better finish. Configurations consist of a single vent tube, vent and short fill tubes, or angled vent and fill tubes. Supplied with a GL-45 open top cap and silicone gasket. Precision pump tubing size to fit adapters is listed.

Vent Port Assemblies

Part Number	Hose Conn. O.D. (mm)	Fits Tub. Size	Description	Thread Size	Price
CLS-1429-10	6.35	17	Single	GL-45	\$150.40 ♥
CLS-1429-20	6.35	17	2-Port	GL-45	\$172.50 ♥
CLS-1429-21	6.35	17	2-Port Angled	GL-45	\$350.10 ♥
CLS-1429-40	4.0	16	2-Port	GL-45	\$178.90 ♥



Addition and Sampling Vessels

Addition and sampling vessel with hose barbed 2-port drip tube assemblies designed for addition or sampling of media, acid or base. Drip tube assemblies are constructed of 316L electropolished stainless steel and include blue polypropylene GL32 open top caps with white silicone gaskets. Drip tubes have a finish of 20Ra or better. The vessel measures 32mm Diameter x 94mm OAL.

Addition and Sampling Vessels

Part Number	Description	Price
CLS-1437-B01	Complete Vessel, 2-Port Drip Tube Assembly	\$210.10 ♥
CLS-1437-B02	Flat Bottom Vessel Only	\$36.50 ♥
CLS-1429-02	2-Port Drip Tube Assembly, Open Top Cap, Gasket	\$189.20 ♥
CLS-1428-14	White Silicone Gasket Only	\$3.80 ♥
CLS-1481-20	Cap, GL-32, Blue, Open Top, PP, Pkg. 6	\$42.90 ♥

Condensers, Glass and Stainless Steel

Condensers aid in removing moisture from exhaust gases which can clog filters. They also help minimize loss of material from the bioreactor due to evaporation during fermentation.

Glass condensers are available in bulb and coil styles and are more economical than stainless steel.

Stainless steel condensers consist of four components: jacketed condenser body with two 1/4-inch hose connections; internal stainless steel baffle; 90° glass outlet tube with 1/4-inch hose connection; threaded compression nut.

Condensers are connected to bioreactors by use of 12mm, adjustable height, probe adapters, CLS-1381-06 or CLS-1381-07 which are sold separately.

Condensers, Glass and Stainless Steel

Part Number	Type	Style	Fits Reactor (L)	Overall Length (mm)	Price
CLS-1380-GC1	Glass	Bulb-Style	2 - 5	150	\$267.90 ♥
CLS-1380-GC2	Glass	Bulb-Style	7	250	\$326.40 ♥
CLS-1385-GC3	Glass	Coil-Style	15	250	\$445.00 ♥
CLS-1380-27	Stainless	—	2 - 5	165	\$1,481.60 ♥
CLS-1383-09	Stainless	—	7	230	\$1,775.10 ♥

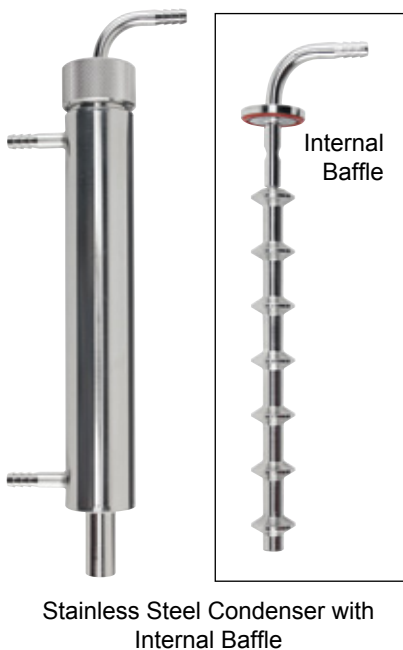

DISCOUNT KEY: * Not Subject to Discount. † Reusable Glass. ♣ Celltreat / Consumable LM Products.

Stirrers, Complete, Bioreactors

Stand alone stirrer fits Applikon®-style vessels from 1 to 5 liters. The motor has incredible power for its size, 91 in-oz. The control box is extremely small, measuring only 3.5" wide x 4.5" high x 2.5" deep, and includes a clamp that allows it to be attached to reactor support legs up to 14mm in diameter. Unit also has a RS-232 port for PC control and data logging.

Specifications

Fits Applikon-Style Vessels	1-5 Liters
Speed Range	20-800 RPM
Power	91 (in-oz.)
Voltage Requirements	110 to 240 VAC, 50-60 Hz
Wattage	240 Watts Max, Peak 2 Amps
Operating Temperature Range	5 to 40°C

Note: Only highlighted portion of inset image is included.

Bioreactor Stirrer Motor with Controller and Cable

Part Number	Description	Price
CLS-1399-100	Stirrer Motor, Controller and Cable	\$2,761.80 ♥

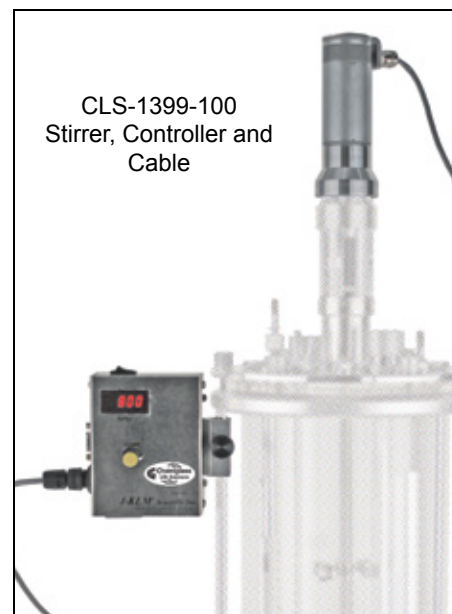

Replacement Silicone O-Rings

Orange silicone o-ring replacements for bioreactors conform to FDA 21CFR Part 177.2600.

Orange Silicone O-Rings

Part Number	I.D. x Cross Section (mm)	Qty.	Price
CLS-1705-007	3.68 x 1.78	20	\$22.05 ♥
CLS-1705-008	4.47 x 1.78	20	\$23.00 ♥
CLS-1705-010	6.07 x 1.78	20	\$26.85 ♥
CLS-1705-85X25	8.50 x 2.50	20	\$37.10 ♥
CLS-1705-111	10.70 x 2.6	20	\$39.60 ♥
CLS-1705-18X3	18.0 x 3.0	20	\$43.45 ♥
CLS-1705-20X2	20.0 x 2.00	20	\$35.15 ♥
CLS-1705-023	26.7 x 1.78	10	\$21.80 ♥
CLS-1705-121	26.6 x 2.62	10	\$23.00 ♥
CLS-1705-124	31.4 x 3.30	10	\$24.30 ♥
CLS-1705-131	42.5 x 2.62	10	\$28.15 ♥
CLS-1705-135X4	135 x 4.00	1	\$67.75 ♥
CLS-1705-150X4	150 x 4.00	1	\$70.30 ♥
CLS-1705-260	166 x 3.00	1	\$84.55 ♥
CLS-1705-177X4	177 x 4.00	1	\$79.30 ♥
CLS-1705-373	228 x 5.33	1	\$81.85 ♥
CLS-1705-274	253 x 3.53	1	\$83.10 ♥

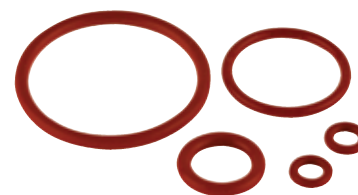

CLS-1705-series

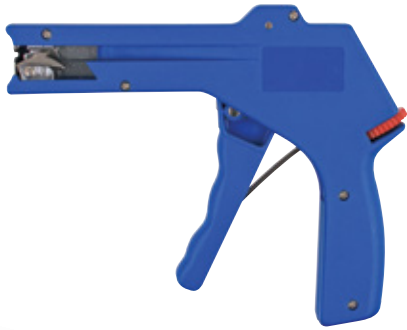

CLS-1399-G100

Cable Tie Gun, Plastic, Adjustable Tension, Zip-Tie

Plastic gun works with cable ties up to 0.19" wide and produces 18-50lbs of tensile strength. Gun tightens and cuts. Not compatible with stainless steel ties.

Adjustable Tension, Cable Tie Gun

Part Number	Description	Price
CLS-1399-G100	Cable Tie Gun, Plastic, Adjustable Tension	\$32.15 ♥

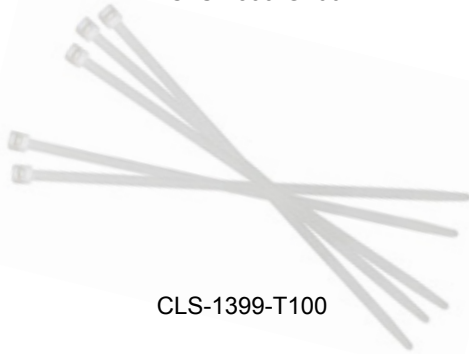

CLS-1399-T100

Cable Ties, 4-inch Length, Nylon 6.6, Autoclavable

Tie wraps are injection-molded of 6.6 nylon and won't corrode or stretch. Durable locking mechanism holds securely. Each natural-color, 4-inch tie is 1/8" wide and has an 18lb strength. Maximum bundle / wrap diameter is 1-inch. Long term temperature range is -40 to 85°C. Short term temperature range is 180°C. Autoclavable.

Nylon Cable Ties, 4-inch

Part Number	Description	Qty.	Price
CLS-1399-T100	Cable Tie, 4" Long, Nylon 6.6, Natural	100	\$5.15 ♥



CLS-1399-F50

Male Luer Lock, Needleless Injection Site, Swabable, Polycarbonate, Silicone, Sampler, Bioreactors

Male Luer Locks

Part Number	Description	Qty.	Price
CLS-1399-F50	Male Luer Lock, Needleless Injection Site, Swabable, Polycarbonate, Silicone	25	\$69.40 ♥



CLS-1399-G50

Female Luer, 1/8" Barb

The female luer thread style to 1/8" barb (3.2mm) ID Tubing is gamma stable and polycarbonate. Ideal for use with CLS-1399-F50.

Female Luer to 1/8" Barb

Part No.	Description	Qty.	Price
CLS-1399-G50	Female Luer, 1/8" barb, PC	25	\$14.10 ♦



CLS-1399-F55

Female to Male Luer Locks, Polycarbonate, Samplers, Bioreactors

Female to Male Luer Locks

Part Number	Description	Qty.	Price
CLS-1399-F55	Female to Male Luer Lock, Polycarbonate	25	\$48.40 ♥

DISCOUNT KEY: * Not Subject to Discount. † Reusable Glass. ♣ Celltreat / Consumable LM Products.

Genesis Tube Sealers

Benchtop and Portable, Battery Operated Models

- Highly integral seals
- Easy to disconnect
- Seals dry or liquid filled tubing
- Widely used in blood bank applications
- Battery powered unit provides portability in areas without AC power

Genesis tubing sealers provide rapid and highly integral tubing seals using lightweight and portable equipment. When the trigger lever is pulled, the Genesis device initiates strong high-frequency energy which melts the thermoplastic Tygon® tubing. The sealing cycle is only about 2 seconds long and can be performed on dry as well as fluid filled tubing.

The seal is designed for easy separation. After the sealing cycle has completed, the tubing can be aseptically parted by pulling on tube itself. No other tools are required and sterility of each side is completely maintained.

Depending on your requirements, you can select an AC powered or a battery powered system. The AC powered model (CLS-1407-12) is equipped with two sealing heads. One is a fixed head mounted on the base, while the other is a tethered hand-held unit. The battery powered model (CLS-1407-10) comes with a tethered head only; it does not have a fixed head.



CLS-1407-10



CLS-1407-12

Genesis Tube Sealers

Part No.	Description	Qty.	Price
CLS-1407-10	Portable, Battery Powered	1	\$5,055.00 *
CLS-1407-12	Benchtop, AC Powered	10	\$6,199.00 *

Versilic™, Peroxide-cured, Silicone Tubing in Rolls

Peroxide-cured Versilic Silicone Tubing is designed for applications where flexibility, resiliency and durability are required. Its inner smooth surface reduces the risk of particulate entrapment and microscopic buildup during fluid transfer.

Tubing is FDA food grade compliant, entirely non-toxic, non-hemolytic and non-pyrogenic. It also meets 3-A Sanitary Standards, FDA 21 CFR Part 177.2600 Criteria and NSF 51 Standard. Withstands temperature extremes from -100°F to 500°F (350°F maximum for NSF applications).

Sold in standard lengths of 50ft.

Versilic, Peroxide-cured, Silicone Tubing in Rolls

Part No.	OD (in.)	ID (in.)	Wall Thick (in.)	Roll Length (ft)	Price
CLS-1436-T20	1/4	1/8	1/16	50	\$55.40 ◇
CLS-1436-T21	5/16	3/16	1/16	50	\$62.80 ◇
CLS-1436-T22	3/8	3/16	3/32	50	\$87.90 ◇
CLS-1436-T23	3/8	1/4	1/16	50	\$73.85 ◇
CLS-1436-T24	7/16	1/4	3/32	50	\$94.70 ◇
CLS-1436-T25	1/2	1/4	1/8	50	\$150.10 ◇



CLS-1436-T24



CHEMcell® Rocker BioReactor System

Provides increased flexibility with modular format, optional trays and accessories.



CLS-1200-100 Base

CLS-1200-250
CLS-1200-300
Rocker Trays

Position Control
Load - Harvest - Run

Speed Control
2 to 40 per minute

Tray Angle Control
2 to 12°

Digital Display
Bright and Easy-to-Read

- Adjustable tray angle
- Variable speed rocking
- Quiet operation
- Optional vent heater
- Two-year warranty



Easy Bag Installation

Increased flexibility with modular format, optional trays and accessories.

Modular benchtop bioreactor system consists of a heavy-duty base unit and a choice of stainless steel rocker trays. Engineered for durability, it can be used in both research and development as well as production environments. The smooth rocking motion provides gentle, efficient mixing and gas transfer. Designed for optimal performance with Chemglass 8-port and 6-port cell culture bags but easily accepts other manufacturers' bags having the same dimensions. The optional bag and vent heater, made for use with both size trays, keeps vent filters free of harmful condensation that can clog filters and compromise cultures.

NOTE: Temperature controller, **CLS-1200-2CH**, must be purchased separately.

Specifications	CHEMcell Base	20 Liter Tray	50 Liter Tray
Weight (lbs)	45	22	34
Dimensions (L x W x H) inches / centimeters	19.5 x 16.6 x 6.5 49.53 x 42.16 x 16.51	21 x 27 x 2.5 53.35 x 68.58 x 6.35	27 x 30 x 2.5 68.58 x 76.2 x 6.35
Rocking Rate (per min.)	2 - 40	—	—
Rocking Angle (°)	2 - 12	—	—
Electrical	110-120V, 480W	—	—

CHEMcell BioReactors

Part No.	Description	Price
CLS-1200-100	CHEMcell® Rocker BioReactor Base Only	\$8,053.90 ♥
CLS-1200-250	CHEMcell® Rocker Tray, 10-20 Liter, Complete, With heater and PT100 Thermocouple	\$3,451.70 ♥
CLS-1200-300	CHEMcell® Rocker Tray, 20-50 Liter, Complete, With heater and PT100 Thermocouple	\$4,027.00 ♥

DISCOUNT KEY: * Not Subject to Discount. † Reusable Glass. ♣ Celltreat / Consumable LM Products.

Vent Heater

Vent heater for use with rectangular filters measuring 40 x 70mm. Use with temperature controller, CLS-1200-2CH.

Vent Heater

Part Number	Description	Qty.	Price
CLS-1200-FH	Vent Heater, 4 Watt	1	\$346.50 ♥



CLS-1200-FH
Vent Heater

Temperature Controller, J-KEM®

Controls heaters on both size trays along with vent heater.

Temperature Controller

Part Number	Description	Qty.	Price
CLS-1200-2CH	Temperature Controller	1	\$1,680.40 ♥

J-KEM is a registered trademark of J-KEM Scientific.



CLS-1200-2CH
Temperature Controller

Gas Mixing Module, CHEMcell™

The CHEMcell gas mixing module with touchscreen display is used for accurate mixing of two gases. It utilizes two Alicat gas flow controllers with built-in back pressure sensors for safe operation with a disposable bag or bioreactor. Flow rates are up to 1.1 liters per minute maximum. Gas totalizers allow you to track the total flow during the cell culture run.

Gas Mixing Module

Part No.	Description	Qty.	Price
CLS-1200-GMM	Gas Mixing Module	1	\$12,313.30 ♥

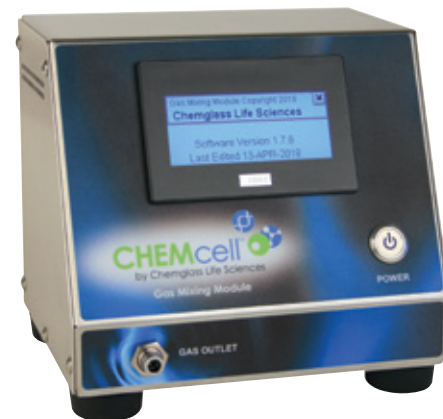

CLS-1200-GMM
Gas Mixing Module

Bags, Cell Culture, Ultra Clear, 6-Port, Compatible with GE Wave™ Rocking Platforms, Cell Culture Bag

Cell culture bags are manufactured from ultra clear Flex 600 robust film and gamma irradiated. The film meets USP Class VI specifications and is contamination free. The inner product contact material is low density polyethylene. All bags and components content materials are USP Class VI tested. Excellent choice for mammalian and plant culture cell lines with extended mixing times.



CLS-1207-series

Six-Port, Ultra Clear, Cell Culture Bags

Part No.	Capacity (L)	No. of Ports	Qty.	Price
CLS-1207-10M	10	6	10	\$3,519.35 ♥
CLS-1207-20M	20	6	10	\$3,745.00 ♥
CLS-1207-22M	22	6	10	\$3,793.30 ♥
CLS-1207-50M	50	6	10	\$4,709.15 ♥

♥ Bioreactor Reactor Discount. ■ Spinner Flasks and Accessories. ♦ Life Sciences Consumables.



Single-Use Media Bottle Assemblies, PETG, Transfer, Feed

- Strain relief stopper prevents kinking
- Manufactured, assembled and packaged in Class 7 cleanroom
- USP Class VI approved materials
- Animal Derived Component Free (ADCF)
- Gamma irradiated to Sterility Assurance Level (SAL) 10-6

Our single-use PETG media bottle assemblies are available in a wide range of standard sizes, from 125mL to 2L. **Each assembly includes a PP, 2-port closure assembly consisting of:**

30mm 0.22µM vent filter

V-notched dip tube extending to the bottle bottom

24-inch length of tubing with 1/4" pinch clamp

Choose Plugged Ends or Male Luer Ends

Single-Use, PETG, Media Bottle Assemblies - Plugged End

	Part No.	Cap. (mL)	No. of Ports	Qty.	Price
PLUGGED END	CLS-1168-0125	125	2	10	\$614.00 *
	CLS-1168-0250	250	2	10	\$679.00 *
	CLS-1168-0500	500	2	5	\$389.00 *
	CLS-1168-1000	1,000	2	5	\$467.00 *
	CLS-1168-2000	2,000	2	5	\$573.00 *

Single-Use, PETG, Media Bottle Assemblies - Male Luers with 1/8" Barbs

	Part No.	Cap. (mL)	No. of Ports	Qty.	Price
MALE LUER	CLS-1168-0125MLC	125	2	10	\$614.00 *
	CLS-1168-0250MLC	250	2	10	\$679.00 *
	CLS-1168-0500MLC	500	2	5	\$389.00 *
	CLS-1168-1000MLC	1,000	2	5	\$467.00 *
	CLS-1168-2000MLC	2,000	2	5	\$573.00 *

Blue Caps, Sterile, Individually Bagged

Part No.	Thread Size	Qty.	Price
CLS-1168-1038	38-430 GPI	20	\$55.90 *
CLS-1168-1053	53B	20	\$67.00 *

Custom Assemblies Available



Let's discuss your specifications.

1.800.843.1794

singleuse@cglifesciences.com

DISCOUNT KEY: * Not Subject to Discount. † Reusable Glass. ♣ Celltreat / Consumable LM Products.

Sample Tube™ Assemblies, 50mL, Sterile, Single-Use, 50mL Centrifuge Tube

The 50mL polypropylene centrifuge tube assembly utilizes a closed cap assembly with 18" of size 16 (1/8" x 1/4") C-Flex tubing inlet line with a pinch clamp and plugged. The assembly includes a 3" vent line with a PTFE filter. Assembly is certified sterile.

The sample tube assembly can be used for sampling and transfer of biopharmaceutical products and reagents in closed systems. Sold individually wrapped in a bag of ten.

Part No.	Vol. (mL)	Cent. Tube Material	Inner Dip Tube Material	Qty.	Price
CLS-1407-T-312	50	PP	C-Flex	10	\$474.90 *

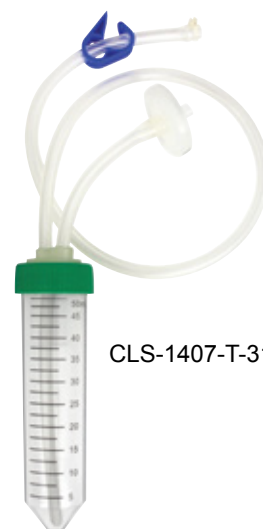

CLS-1407-T-312

OmniTop Sample Tube™ Assemblies, Pre-Sterilized, Single-Use, 15mL and 50mL Centrifuge Tubes

- Transfer of biopharmaceutical products and reagents in a closed system
- Gas exchange transfer
- Sampling of biopharmaceutical products and reagents in a closed system
- Storage of biopharmaceutical products and reagents
- Use with bench top, pilot plant and production bioreactors
- Use with sterile connecting devices and thermal or RF tubing sealers

OmniTop Sample Tubes are convenient devices that can be used to obtain fluid samples. Each OmniTop tube comes with a pre-attached 0.2µm vent filter and 18" of C-Flex® tubing. They are available with or without internal dip-tubes to facilitate removal of the fluid inside.

OmniTop Samples Tubes can be aseptically connected to your bio reactor or other device using standard tubing welders. Sample Tubes can also be aseptically sealed and removed (wet or dry) using tubing sealers.

Blue caps indicate the tubes are polypropylene. **Purple caps** indicate the tubes are polystyrene.

Custom Sample Tube Assemblies Available: tech@cglifesciences.com

15mL Assemblies with C-Flex Inlets, Double Bagged & Gamma Irradiated

Part No.	Vol. (mL)	Cent. Tube Material	Inner Dip Tube Material	Qty.	Price
CLS-1407-T-015	15	PP	no dip tube	10	\$516.60 *
CLS-1407-T-115	15	PS	no dip tube	10	\$516.60 *

50mL Assemblies with C-Flex Inlets, Double Bagged & Gamma Irradiated

Part No.	Vol. (mL)	Cent. Tube Material	Inner Dip Tube Material	Seal Tube	Qty.	Price
CLS-1407-T-10	50	PP	PP	yes	10	\$541.20 *
CLS-1407-T-12	50	PP	PP	no	10	\$541.20 *

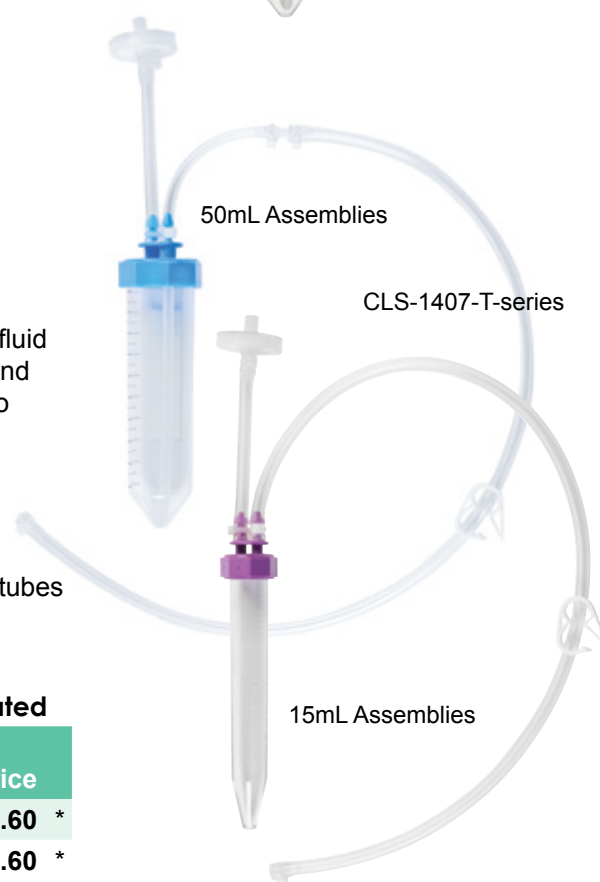

50mL Assemblies

CLS-1407-T-series

15mL Assemblies

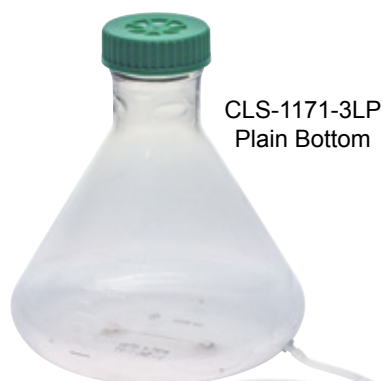

CLS-1171-3LP
Plain Bottom



CLS-1171-3LB
Baffled Bottom



CLS-1436-C01

3L Media Transfer Vessels with Barbed Fittings, Weldable C-Flex Tubing, Plugged, Plain or Baffled Bottom, Sterile

Media transfer vessels are ideal for doing gravity feeds from sterile 3L vessels. Fernbach flasks are sterile and individually double bagged.

Three liter polycarbonate flasks with filter caps have 3/16" barbed fittings that accept 1/8" ID, 1/4" OD weldable C-Flex® tubing ending in a plug. Each is supplied complete with a tubing clamp. Irradiated sterile. Call for bulk pricing.

3L Media Transfer Vessels, Sterile, Complete

Part No.	Bottom Type	Qty.	Price
CLS-1171-3LP	Plain	1	\$239.20 *
CLS-1171-3LB	Baffled	1	\$239.20 *

Flow Control Tube Clamps, 1/2-inch OD

Acetal clamp is autoclavable; won't rust, corrode or distort. Twelve position ratchet control adjusts from full flow to complete closure. Accepts tubing up to 1/2" OD. Packed 1 per case.

Flow Control Tube Clamps

Part No.	Description	Qty.	Price
CLS-1436-C01	Tube Clamp, Flow Control, 1/2" OD	1	\$10.00 ◇
CLS-1436-C02	Tube Clamp, Flow Control, 1/2" OD	25	\$37.20 ◇

DISCOUNT KEY: * Not Subject to Discount. † Reusable Glass. ♣ Celltreat / Consumable LM Products.



SCMPC250PC Special



MPCK32003 Sealing Cap with Lock Quick Connect



CLS-1171-5LQC

Tubing Clamp included ▶

Platinum-cured Silicone Tubing ▶



Plugged End



CLS-1171-5LWT

Tubing Clamp included ▶

C-Flex Tubing ▶

5L Sterile Media Transfer Flask with Platinum-Cured Silicone Tubing and Quick Disconnect

- Quick disconnect fitting on tubing
- 1/4" ID x 7/16" OD platinum-cured silicone tubing

Dual purpose, 5L transfer flasks are designed for the sterile transfer of liquids as well as for single-use inoculation vessels. They're ideal for use doing gravity feed from sterile, 5L vessels.

Erlenmeyer-style, polycarbonate flask includes a cap with 0.2 µm hydrophobic filter, 3/16" barbed fitting, 1/4" ID x 7/16" OD platinum-cured tubing, tubing clamp and quick disconnect. Supplied gamma irradiated, sterile and individually double bagged.

5L Media Transfer Flask with Quick Disconnect

Part No.	Vol. (L)	Qty.	Price
CLS-1171-5LQC	5	1	\$259.20 *

5L Sterile Media Transfer Flask with C-Flex® Tubing and Plugged End

- Tubing end is plugged
- 1/4" ID X 3/8" OD weldable, C-Flex tubing

Dual purpose, 5L transfer flasks are designed for the sterile transfer of liquids as well as for single-use inoculation vessels. They're ideal for use doing gravity feed from sterile, 5L vessels.

Erlenmeyer-style, polycarbonate flask includes a cap with 0.2 µm hydrophobic filter, 1/4" barbed fitting, 1/4" ID x 3/8" OD or 1/4" ID x 7/16" OD weldable C-Flex® tubing with a plugged end and tubing clamp. Supplied gamma irradiated, sterile and individually double bagged.

5L Media Transfer Flask with Plugged Tubing

Part No.	Tube Size	Vol. (L)	Qty.	Price
CLS-1171-5LWT	17	5	1	\$259.20 *
CLS-1171-5LWB	24	5	1	\$259.20 *

CUSTOM FLUID TRANSFER SOLUTIONS designed for the unique needs of your process.



CONTACT US
 1.800.843.1794
singleuse@cglifesciences.com

♥ Bioreactor Reactor Discount. ■ Spinner Flasks and Accessories. ◇ Life Sciences Consumables.

new



CGN-2165-2LSC (solid cap)
CGN-2165-2L (vent cap)

new



CGN-2165-3LSC (solid cap)
CGN-2165-3L (vent cap)



Solid Cap

NEST High Efficiency Polycarbonate Flasks with Solid or Vent Caps , Sterile, USP Class VI

- Polycarbonate has high standard of transparency and the flask has a clear graduation scale for easy observation.
- Sterilized by E-Beam
- Non-Pyrogenic
- Packaged in sterile bags, 4 per case

Tips

- Recommended volume: 30-40% of the bottle volume.
- Rotation speed suggestion: the starting speed is 75-125RPM, you can control the rotation speed according to the application.

The imported medical-grade polycarbonate that meets with the requirements of ISO 10993 USP<661> is chosen as the raw materials, which has high transparency, great impact resistance, oxidation resistance and can withstand a high temperature of up to 121°C. The scale is clear and accurate when looked at from the outside, which facilitates the observation of the volume of culture medium. The vent cap is equipped with a 0.22µm breathable film which is air-permeable and water-proof to efficiently prevent the passing of micro-organisms and contamination and to ensure gas exchange for good growth of cells or bacteria. The products have undergone the tightness test, drop test, high-temperature and high-voltage tests, flatness test, tensile test, endotoxin test, sterilization test, DNA/RNA enzyme-free tests and cell culture test, all the results of which meet the corresponding quality standards.

NEST Multi-function, Liquid Transfer Caps

The multifunctional transfer cap can be directly placed in an incubator for culture after the liquid transfer is completed. It can reach a large air flux. The sampling part is composed of a sampling nozzle and a one-way valve, which can prevent the liquid from flowing backwards during the sampling process and ensure the aseptic sampling. The liquid inlet tubing is provided with a PTFE needle filter, which solves the issue of liquid remaining in the tubing during the feeding process.

Part No.	Fits	Qty.	Price
CGN-2165-785	2L	CS4	\$861.00 *
CGN-2165-786	3L	CS4	\$913.00 *
CGN-2165-787	3L Wide Mouth & 5L	CS4	\$905.50 *

DISCOUNT KEY: * Not Subject to Discount. † Reusable Glass. ♣ Celltreat / Consumable LM Products.

NEST 2 Liter, High Efficiency, PC Flasks with Caps, Sterile

Part No.	Volume (L)	Cap Type	Qty.	Price
CGN-2165-2LSC	2	solid	4	\$150.00 *
CGN-2165-2L	2	vent	4	\$153.50 *

NEST 3 Liter, High Efficiency, PC Flasks with Caps, Sterile

Part No.	Volume (L)	Cap Type	Qty.	Price
CGN-2165-3LSC	3	solid	4	\$256.00 *
CGN-2165-3L	3	vent	4	\$259.00 *

NEST 3 Liter, Wide Mouth High Efficiency, PC Flasks with Caps, Sterile

Part No.	Volume (L)	Cap Type	Qty.	Price
CGN-2165-3WSC	3	solid	4	\$256.00 *
CGN-2165-3W	3	vent	4	\$259.00 *

NEST 5 Liter, Polycarbonate Flasks with Filter Vent Caps, Sterile

Part No.	Volume (L)	Cap Type	Qty.	Price
CGN-2165-5LSC	5	solid	4	\$376.50 *
CGN-2165-5L	5	vent	4	\$387.50 *



new

CGN-2165-3WSC (solid cap)
CGN-2165-3W (vent cap)



new

CGN-2165-5LSC (solid cap)
CGN-2165-5L (vent cap)



0.22µm PTFE Filter

One-way Valve

PTFE Filter

Cap with Large, Filter Membrane

new



Vent Cap



Vent Cap

CGN-2092-series

Erlenmeyer PETG Flasks with HDPE Vent Caps, Flat Base, Sterile, Nest

- PETG flask with HDPE vent cap
- Ideal for shaker culture applications.
- Sterilized by E-Beam
- Non-pyrogenic
- Packaged in sterile bags
- Breathable membrane
- 0.22µm hydrophobic filter for gas exchange
- Non-toxic and environmentally friendly

PETG Erlenmeyer Flasks with HDPE Vent Caps, Sterile

Part No.	Cap. (mL)	Qty.	Reg. Price	SALE Price
CGN-2092-125	125	24	\$115.50	\$92.40 ♣
CGN-2092-250	250	12	\$79.50	\$63.60 ♣
CGN-2092-500	500	12	\$108.00	\$86.40 ♣
CGN-2092-1000	1,000	6	\$90.00	\$72.00 ♣

Polycarbonate Erlenmeyer Flasks with Vent Caps, Graduated, Individually Bagged, Sterile

- Designed for mammalian suspension culture applications as well as bacterial & yeast culture
- Polycarbonate available with vent cap only
- Vent caps with over-sized vent area feature 0.22µm hydrophobic membrane which allows for improved gas exchange without contamination
- Avoid contamination with single-use, pre-sterilized flasks
- Lightweight material is easier to handle than glass
- Bottles include molded graduation lines
- Individually bagged for easy storage and handling
- Medical grade virgin Polycarbonate is autoclavable

Polycarbonate Erlenmeyer Flasks with Vent Caps, Graduated, Individually Bagged, Sterile

Part No.	Cap. (mL)	Qty.	Reg. Price	SALE Price
CLS-2094-125	125	12	\$123.00	\$98.40 ♣
CLS-2094-250	250	12	\$137.00	\$109.60 ♣
CLS-2094-500	500	12	\$173.00	\$138.40 ♣



CLS-2094-series

DISCOUNT KEY: * Not Subject to Discount. † Reusable Glass. ♣ Celltreat / Consumable LM Products.

Flasks, Erlenmeyer, Baffled, Sterile, Polycarbonate

Quadruple baffled Erlenmeyer flasks are sterile, non-pyrogenic and manufactured with polycarbonate resin. Flasks are supplied with either exclusive DuoCap® designed for both aerobic and anaerobic applications (for aerobic applications the cap utilizes a 0.22µm pore size PTFE membrane for sterile air exchange; for anaerobic applications the cap can easily be converted to a solid cap design) or green filter caps. Solid top caps are also ideal for applications requiring mixing, shaking and storage of biological fluids. Graduations are molded for accuracy. New EZ-Tear packaging allows for easy access.

Baffled, Polycarbonate, Erlenmeyer Flasks, Sterile

Part No.	Cap. (mL)	GPI Thread Size	Qty.	Price
Baffled Flasks with Blue Duo Caps				
CLS-2093-125S	125	38-430	24	\$231.50 ◇
CLS-2093-250S	250	38-430	12	\$136.15 ◇
CLS-2093-500S	500	38-430	12	\$180.70 ◇
CLS-2093-100S	1000	53-B	6	\$135.95 ◇
CLS-2093-200S	2000	53-B	6	\$162.55 ◇
Baffled Flasks with Blue Duo Caps in Bulk Packs				
CLS-2091-125B	125	38-430	144	\$1,265.70 ◇
CLS-2091-250B	250	38-430	72	\$743.85 ◇
CLS-2091-500B	500	38-430	48	\$657.40 ◇
CLS-2091-100B	1000	53-B	24	\$494.25 ◇
CLS-2091-200B	2000	53-B	24	\$592.25 ◇

Flasks, Erlenmeyer, Plain, Sterile, Polycarbonate

Erlenmeyer flasks are sterile, non-pyrogenic and manufactured with polycarbonate resin. Flasks are supplied with exclusive DuoCap® designed for both aerobic and anaerobic applications. For aerobic applications the cap utilizes a 0.22µm pore size PTFE membrane for sterile air exchange. For anaerobic applications the cap can easily be converted to a solid top design. Solid top caps are also ideal for applications requiring mixing, shaking and storage of biological fluids. Graduations are molded for accuracy. New EZTear packaging allows for easy access.

Polycarbonate Erlenmeyer Flasks with Blue Duo Caps

Part No.	Cap. (mL)	GPI Thread Size	Qty.	Price
Plain Flasks with Blue Duo Caps				
CLS-2092-125S	125	38-430	24	\$226.35 ◇
CLS-2092-250S	250	38-430	12	\$132.55 ◇
CLS-2092-500S	500	38-430	12	\$180.70 ◇
CLS-2092-100S	1000	53-B	6	\$134.65 ◇
CLS-2092-200S	2000	53-B	6	\$163.30 ◇
Plain Flasks with Blue Duo Caps in Bulk Packs				
CLS-2090-125B	125	38-430	144	\$1,265.70 ◇
CLS-2090-250B	250	38-430	72	\$743.85 ◇
CLS-2090-500B	500	38-430	48	\$657.40 ◇
CLS-2090-100B	1000	38-430	24	\$494.25 ◇
CLS-2090-200B	2000	38-430	24	\$592.25 ◇



♥ Bioreactor Reactor Discount. ■ Spinner Flasks and Accessories. ◇ Life Sciences Consumables.



CLS-2171-series

Flasks, Polycarbonate, Vented Caps, Baffled Bottom

CELLTREAT® Erlenmeyer and Fernbach culture flasks are designed for shaker and cell culture applications. All flasks feature a 70mm neck size that provides easy access for filling and dispensing. The unique shape of the Fernbach flask provides an increased surface area to volume ratio for improved gas exchange. The flasks are available in 2L Erlenmeyer, 2L and 3L Fernbach sizes, with baffled bottoms. The polypropylene caps are knurled for secure grip and are configured in 70mm large vent or non-vented styles. The flasks are constructed from an optically clear polycarbonate material that can be autoclaved. All flasks include a vented cap and are individually packed in bags and gamma irradiation sterilized. Additional caps are available separately.

Polycarbonate Flasks with Baffled Bottoms and Vented Caps

Part No.	Type	Vol. (L) / Max. Vol. (mL)	Cap Size (mm)	Qty.	Reg. Price	SALE Price	
CLS-2171-EB2L	Erlenmeyer	2 / 2,200	70	6	\$282.00	\$225.60	♣
CLS-2171-FB2L	Fernbach	2 / 2,400	70	6	\$323.00	\$258.40	♣
CLS-2171-FB3L	Fernbach	3 / 4,000	70	4	\$319.00	\$255.20	♣

Polypropylene Caps

Part No.	Cap Type	Cap Size (mm)	Qty.	Reg. Price	SALE Price	
CLS-2172-V070	vented	70	24	\$190.00	\$152.00	♣
CLS-2072-S070	solid	70	24	\$96.00	\$76.80	♣

Flasks, Polycarbonate, Vented Caps, Plain Bottom

CELLTREAT® Erlenmeyer and Fernbach culture flasks are designed for shaker and cell culture applications. All flasks feature a 70mm neck size that provides easy access for filling and dispensing. The unique shape of the Fernbach flask provides an increased surface area to volume ratio for improved gas exchange. The flasks are available in 2L Erlenmeyer, 2L and 3L Fernbach sizes, with plain bottoms. The polypropylene caps are knurled for secure grip and are configured in 70mm large vent or non-vented styles. The flasks are constructed from an optically clear polycarbonate material that can be autoclaved. All flasks include a vented cap and are individually packed in bags and gamma irradiation sterilized. Additional caps are available separately.

Polycarbonate Flasks with Plain Bottoms and Vented Caps

Part No.	Type	Vol. (L) / Max. Vol. (mL)	Cap Size (mm)	Qty.	Reg. Price	SALE Price	
CLS-2170-EP2L	Erlenmeyer	2 / 2,200	70	6	\$279.00	\$223.20	♣
CLS-2170-FP2L	Fernbach	2 / 2,400	70	6	\$319.00	\$255.20	♣
CLS-2170-FP3L	Fernbach	3 / 4,000	70	4	\$317.00	\$253.60	♣

Polypropylene Caps

Part No.	Cap Type	Cap Size (mm)	Qty.	Reg. Price	SALE Price	
CLS-2172-V070	vented	70	24	\$190.00	\$152.00	♣
CLS-2072-S070	solid	70	24	\$96.00	\$76.80	♣



CLS-2170-series

DISCOUNT KEY: * Not Subject to Discount. † Reusable Glass. ♣ Celltreat / Consumable LM Products.

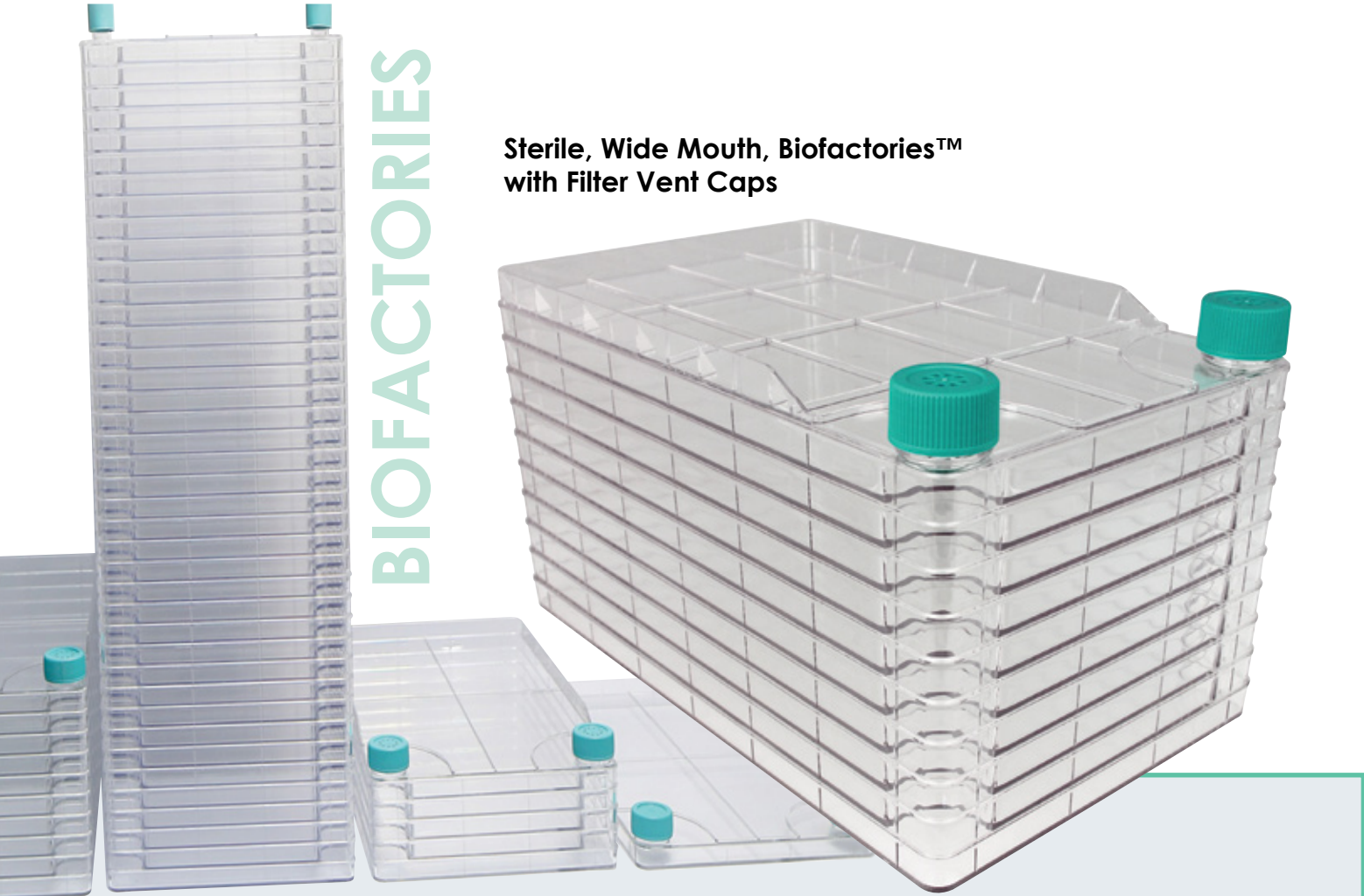

Sterile, Wide Mouth, Biofactories™ with Filter Vent Caps

BIOFACTORIES

- Packed in double-layer sterile bags
- Clear lot numbers for batch traceability
- Ultrasonic welding process without any chemical addition
- Surface TC treatment ensures efficient cell attachment

NEST Biofactory™ systems make maximum use of the culture area available in a limited amount of space. They're useful for industrial scale production of vaccines, monoclonal antibodies and in biopharmaceuticals production. Also suitable for adherent cell culture.

Wide Mouth Biofactories with Filter Vent Caps - Tissue Culture Treated

Part No.	No. of Layers	Total Culture Area (cm2)	Qty.	Reg. Price	SALE Price
CGN-7710-001	1	647	8	\$488.50	\$390.80 ♣
CGN-7710-002	2	1279	8	\$753.00	\$602.40 ♣
CGN-7710-005	5	3175	4	\$551.00	\$440.80 ♣
CGN-7710-010	10	6335	6	\$1,051.50	\$841.20 ♣
CGN-7710-040	40	25295	2	\$1,001.50	\$801.20 ♣

Manufactured in dedicated 10,000-class clean rooms following GMP standards to ensure product quality and stability.

In-house E-beam sterilization meets the ISO13485 and ISO 11137:2006 standards and achieves sterility level SAL = 10⁻⁶.

Compatible with Corning® CellSTACK® culture chamber accessories.

♥ Bioreactor Reactor Discount. ■ Spinner Flasks and Accessories. ♦ Life Sciences Consumables.



CLS-1314

Extremely Compact
Fits in most CO₂ incubators.

BelloCell® High Density Cell Culture System Complete

- Includes a BelloStage® compressor, and necessary accessories
- Extremely compact system fits in most standard CO₂ incubators
- Controller with large bright display and large touch panel
- Easy to read and operate
- Suitable for batch or semi-batch operation
- Suitable for most protein and monoclonal antibodies production applications

The BelloCell® Cell Culture System Complete contains all the necessary elements for users to start cell culture. It is designed to support four BelloCell® -500 bottles with a 8.6" x 11.7" foot-print and fits inside a standard CO₂ incubator. It contains a BelloStage® console with a magnetized controller, which can be conveniently mounted and accessed from the outside of the incubator. One-year warranty on equipment.

BelloCell® System Complete

Part Number	Component Description	System Qty.	Price
CLS-1314-02	BelloStage®- 3000 Machine	1	Call *
	GlucCell® Glucose Meter	1	
	Glucose Test Strips, 50 ea.	50	
	CD / Manual	1	

BelloCell® BelloStage® - 3000 Machine Only

Part Number	Component Description	Qty.	Price
CLS-1313-01	BelloStage®-3000 Machine	1	Call *
	Main Console	1	
	Control Box	1	
	Power Adapter, 100~240V	1	
	Signal Cable	1	
	CD / Manual	1	

BelloCell® Accessories

Part Number	Component Description	Qty.	Price
CLS-1336-01	Filtered Cap	6	\$242.05 *
CLS-1338-01	Solid Cap	8	\$159.60 *
CLS-1342-01	Forceps	1	\$118.40 *



CLS-1332-01

Crystal Violet Dye Nucleus Count Kit

Crystal Violet Dye Nuclei Count Kit contains crystal violet dye, citric acid and detergent to disrupt cells and release cell nuclei for cell count. This provides an efficient reagent for cell count in a porous matrix. Volume: 100mL / Bottle.

Crystal Violet Dye Nucleus Count Kit

Part Number	Description	Qty.	Price
CLS-1332-01	100mL per Bottle	1	\$91.55 *

DISCOUNT KEY: * Not Subject to Discount. † Reusable Glass. ♣ Celltreat / Consumable LM Products.

BelloCell® Continuous System Complete

- Each bottle connects with an independent media reservoir to eliminate cross-contamination
- Programmable and ON / OFF pumping control simplifies the setting of recirculation rate for each bottle
- One BelloFeeder® pump module operates up to 4 pump heads with individual micro-processor control
- Suitable for cell mass production, cell component production, virus production or protein expression

The BelloCell® Continuous Cell Culture System Complete provides similar features to the BelloCell Cell Culture System Complete but with an additional BelloFeeder® pump and tubing sets to provide continuous media exchange in the BelloCell® - 500P bottles.

Each BelloCell® - 500P bottle has additional inlet and outlet line for media recirculation. Each bottle can link to an extra glass media vessel (not included) and provide continuous exchange of nutrient, eliminating the need for media exchange and avoiding possible shock to the cells during culture.

Each Package Contains:

- 1 BelloStage® - 3000 Compressor
- 1 BelloFeeder® Pump Module
- 2 Complete Tubing Sets
- 1 GlucCell® Glucose Meter
- 50 Glucose Test Strips
- 1 CD/Manual

One-year warranty on equipment.

BelloCell® Continuous System Complete

Part Number	Component Description	Qty.	Price
CLS-1317-02	BelloCell Continuous System Complete	1	Call *
CLS-1320-04	BelloFeeder®-1400 Pump	1	Call ♥



CLS-1317

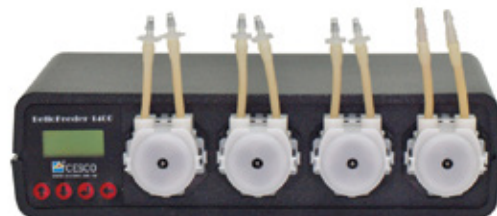

CLS-1320-04 BelloFeeder® 1400 Pump

Disposable Tubing Sets

Tubing Complete Set includes pre-assembled tubes, reusable pump head and head plate with a sampling port to support the continuous culture in BelloCell®-500P system. It can be autoclaved at 121° C for 30 minutes.

Disposable Tubing Sets

Part Number	Disposable Tubing Sets	Qty.	Price
CLS-1326-01	Tubing Kit, Pump Head & Head Plate	1	\$526.55 *
CLS-1328-01	Tubing Kit & Pump Head	1	\$462.00 *

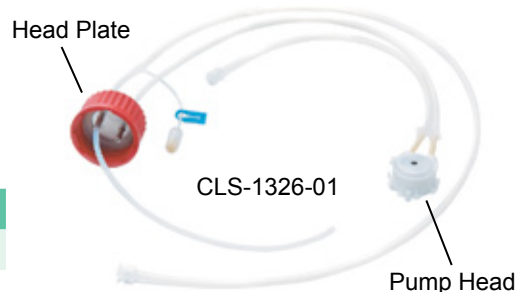

Disposable Tubing Accessory Kit

Replaces tubing in the Tubing Complete Set. It is recommended that tubing be replaced after three uses.

Disposable Tubing Accessory Kit

Part Number	Component Description	Qty.	Price
CLS-1330-01	Disposable Tubing Accessory Kit	1	\$423.55 *



CLS-1330-01

♥ Bioreactor Reactor Discount. ■ Spinner Flasks and Accessories. ♦ Life Sciences Consumables.



GlucCell® Monitoring System includes a palm size meter and disposable test strips, enabling instant and accurate reading for glucose monitor during cell culture.



Disposable test strips, 3µl sample, and palm size meter enable operation in a biosafety cabinet, eliminating the risk of contamination by biohazardous samples.

GlucCell® Glucose Monitoring System

- Suitable for both serum and serum-free culture medium in mammalian and insect cell culture
- Portable, pre-calibrated, ready-to-use, plug & play, and disposable
- 99.5% correlated with NOVA and YSI biochemical analyzer
- Precision: >95%, Accuracy >90%, Linearity = 0,9997
- Programmable
- One-year warranty on meter

GlucCell® Glucose Monitoring System speeds and simplifies your glucose measurement during cell culture. GlucCell® Glucose Monitoring System is specially designed for measuring the glucose metabolites during animal cell culture, unlike general diabetes glucose meters on the market that are not applicable for animal cell culture.

This package contains a portable, palm size glucose meter and pre-calibrated, disposable test strips, designed for measuring the glucose concentration during mammalian cell and insect cell culture.

GlucCell® Glucose Monitoring System is intended for use by laboratory researchers or bioreactor professionals to obtain a quantitative measurement of glucose in cell culture media. It is made to meet your needs with calibration-free, maintenance-free, high accuracy, instant, disposable and portable.

One-year warranty on equipment.

Specifications

Dimension	96 mm x 60 mm x 18.5 m/m
Weight	70 g including battery
Power source	CR2032 3V Lithium coin battery X 1
Battery Life	Approximately 1,000 tests
Display	Large LCD
Memory	Store 180 test results with date and time
	Auto electrode inserting detection
Automation	Auto sample loading detection
	Auto reaction time count-down/Auto turn-off
Environment	10 - 40 ~ C (50-104 ~ F) , 20-80 RH
Strip size	45 mm x 6 mm x 0.6 mm
Require sample	3-10µl
Measure range	30-550 mg/dl (1 .6-30.6 mmol/L)
Test result time	15 seconds

GlucCell® Glucose Monitoring System

Part Number	Description	Package	Price
CLS-1322-02	GlucCell® Glucose Monitoring System	1 ea. Glucose Meter, 2 ea. bottles, each contains 25 strips	\$521.25 *
CLS-1324-01	GlucCell® Glucose Test Strips	2 ea. bottles, each contains 25 strips	\$84.10 *

DISCOUNT KEY: * Not Subject to Discount. † Reusable Glass. ♣ Celltreat / Consumable LM Products.



Dura-Mag™ Digital Magnetic Stirrers

Available in 2-, 5- and 9-position models

Quiet, brushless, maintenance-free motors

Optional, factory-installed, motion alarms available

See CLS-4100-series
Dura-Mag Stirrers and
CLS-1430-series
Spinner Flasks at:

www.cglifesciences.com



Bioprocess Spinner Flasks in a Variety of Styles and Sizes

Capacities from 25mL to 15 liters

Dimpled and flat-bottom, borosilicate, glass vessels

Completely assembled flasks and component parts in stock

Replacement impeller assemblies, stir shafts and cap assemblies



CLS-1404-series

Vessels, Bioreactors, 4-Necks

Vessel has four vertical GL-45 threaded side necks and a 100mm threaded center neck. The 3 and 6 liter vessels are low profile to maximize incubator space. Supplied complete with (4) solid GL-45 caps and (4) pouring rings.

Four-Neck, Graduated Bioreactor Vessels

Part No.	Cap. (L)	Center Neck GPI Thread	Side Necks Size	Qty.	Price
CLS-1404-03	3	100-440	GL-45	1	\$1,034.00 ♦
CLS-1404-06	6	100-440	GL-45	1	\$1,076.60 ♦
CLS-1404-08	8	100-440	GL-45	1	\$1,190.80 ♦
CLS-1404-15	15	100-440	GL-45	1	\$1,726.80 ♦



CLS-1406-series

Vessels, Bioreactors, 6-Necks

Vessel has six vertical GL-45 threaded side necks and a 100mm threaded center neck. The 3 and 6 liter vessels are low profile to maximize incubator space. Supplied complete with (6) solid GL-45 caps and (6) pouring rings.

Six-Neck, Graduated Bioreactor Vessels

Part No.	Cap. (L)	Center Neck GPI Thread	Side Necks Size	Qty.	Price
CLS-1406-03	3	100-440	GL-45	1	\$1,294.20 ♦
CLS-1406-06	6	100-440	GL-45	1	\$1,331.60 ♦
CLS-1406-08	8	100-440	GL-45	1	\$1,552.00 ♦
CLS-1406-15	15	100-440	GL-45	1	\$1,744.20 ♦
CLS-1406-36	36	100-440	GL-45	1	\$2,779.60 ♦

Vessel Carriers, Bioreactors

Manufactured from 304 Stainless Steel and electro-polished. Vessel carriers are very stable and allow for easy transport of Bioreactor Vessels, Spinner Flasks or large Carboys.

Carriers for Bioreactor Vessels

Part No.	Fits Vessel Sizes (L)	Height x Overall Diameter (in.)	Qty.	Price
CLS-1406-C06	6	9 x 8	1	\$156.60 ♥
CLS-1406-C08	8 (plus 3 and 6 Low Profile)	11 x 10	1	\$165.15 ♥
CLS-1406-C15	15	12 x 11	1	\$206.15 ♥
CLS-1406-C36	36	17 x 13	1	\$241.20 ♥



CLS-1406-C-series

DISCOUNT KEY: * Not Subject to Discount. † Reusable Glass. ♣ Celltreat / Consumable LM Products.

Dura-Drive Overhead Motors, Standard

- Easy mounting bracket with 'peg & grommet' design
- Twist-lock, power cord plug safely prevents disconnection from power source

Dura-Drive overhead motors are designed for use with SS or PTFE impellers to stir media or other liquids in bio reactor vessels and spinner flasks. A CLS-1440 overhead drive adapter is required with this motor. Includes power supply.

Dura-Drive Overhead Motor

Part No.	Voltage	Qty.	Price
CLS-1440-100	120	1	\$2,316.40 ♥

Overhead Drive Adapter, Standard

The standard overhead drive adapter is used to attach a standard overhead drive motor to a SS or PTFE impeller for use with bioreactor vessels or spinner flasks. The adapter is manufactured from 316L electropolished SS with polyester / SS bearings.

Overhead Drive Adapter

Part No.	Dimensions	Qty.	Price
CLS-1440-10	161mm OAH, 78mm from cap to top	1	\$1,421.70 ♥

Overhead Drive Adapter, Preventative Maintenance Kit

CGLS PM Kits include all of the high maintenance items required to keep your Overhead Drive Adapters functioning to the high standards. Each kit contains an illustrated parts list for easy identification of parts.

Maintenance Kit for Overhead Drive Adapter

Part No.	Description	Qty.	Price
CLS-1440-K1	Maintenance Kit with:	1	\$317.90 ♥
	#118 Silicone O-Ring	1	
	Shaft Seal	2	
	Polyester Ball Bearing	2	
	Internal Retaining Ring	2	
	Drive Shaft Grip Ring	1	
	Replacement Shaft	1	



CLS-1440-100



CLS-1440-10



Stainless Steel Pitch Blades for Dura Drive Motors

- folding impeller assemblies
- optimum agitation for VSA vessels
- improves uplift and increases mass transfer rates
- minimize shear

See [CLS-1440-P-series Pitch Blades on the web.](#)

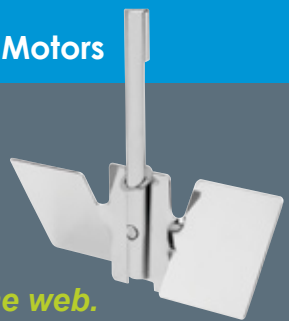



CLS-1440-series



CLS-1437-series
Thermowell Assemblies

Impeller Assemblies for Overhead Drives, PTFE

Our PTFE impeller assemblies are designed to provide agitation for our vertical side arm (VSA) vessels and spinners when used with our cap adapter and Dura Drive overhead motor.

NOTE: Stainless steel impeller assemblies are available as special order. Please contact us for details.

Impeller Assemblies for Overhead Assemblies

Part No.	Fits Vessel	Overall Width x Overall Height (mm)	Qty.	Price
CLS-1440-26	3L Spinner	108 x 222	1	\$217.50 ♥
CLS-1440-27	6L Spinner	171 x 355	1	\$276.10 ♥
CLS-1440-28	8L VSA	171 x 337	1	\$242.60 ♥
CLS-1440-29	15L VSA	171 x 368	1	\$251.00 ♥
CLS-1440-30	36L VSA	241 x 442	1	\$267.60 ♥

Low Profile Impeller Assemblies for Overhead Assemblies

Part No.	Fits Vessel	Overall Width x Overall Height (mm)	Qty.	Price
CLS-1440-44	3L VSA	171 x 162	1	\$167.40 ♥
CLS-1440-54	6L VSA	171 x 207	1	\$172.40 ♥

Thermowell Assemblies, 3-Port, SST, with Hose Barbs for VSA Vessels

Our 3-port large diameter thermowell assemblies are designed to accommodate a wide variety of RTD's and dial thermometers of different diameters for measuring the process temperature in our vertical sidearm bioreactor vessels. All 316L stainless steel tubes have an electro-polished finish of a Ra 20µ or better, inside and out. These assemblies feature a thermowell tube with 0.375" OD and 0.305" ID that will accept all 1/4" thermometer probes. These assemblies include a blue open top GL45 polypropylene cap with a white silicone gasket.

3-Port Thermowell Assemblies

Part No.	Fits Vessel	Qty.	Price
CLS-1437-60	3L VSA	1	\$309.40 ♥
CLS-1437-61	6L VSA	1	\$376.40 ♥
CLS-1437-62	8L VSA	1	\$384.90 ♥
CLS-1437-63	15L & 36L VSA	1	\$401.40 ♥

DISCOUNT KEY: * Not Subject to Discount. † Reusable Glass. ♣ Celltreat / Consumable LM Products.

Harvest Tube Assemblies, 3-Port, SST, with Hose Barbs for VSA Vessels

Our 3-port harvest assemblies are designed for insertion into our vertical sidearm bioreactor vessels. They are manufactured with 1/4" and 3/8" 316L stainless steel tubing and facilitate rapid removal of liquid from bioreactor vessels. Harvest tube assemblies have an electro-polished finish of Ra 20µ or better, inside and out. Includes a blue open top GL45 polypropylene cap with a white silicone gasket.

3-Port Harvest Tube Assemblies

Part No.	Fits Vessel	Qty.	Price
CLS-1437-70	3L VSA	1	\$376.40 ♥
CLS-1437-71	6L VSA	1	\$384.90 ♥
CLS-1437-72	8L VSA	1	\$401.40 ♥
CLS-1437-73	15L & 36L VSA	1	\$418.10 ♥

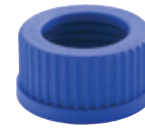

CLS-1437-series Harvest Tube Assemblies

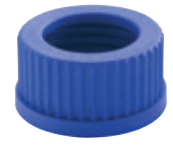

CLS-1437-A10 Addition Dip Tube Assemblies



Addition Dip Tube Assemblies, 3-Port, SST, with Hose Barbs

Our hose barbed 3-port dip tube assemblies are designed for addition or sampling of media from Vertical Side Arm (VSA) Bioreactor Vessels. These addition dip tube assemblies are ideal for liquid addition of acid, base, antifoam or media. They are constructed of 316L stainless steel, electropolished to a 20Ra (or better) finish and include a blue, polypropylene GL45 open top cap and white silicone gasket. Tube lengths are 3-3/32" long.

3-Port Addition Dip Tube Assembly

Part No.	Qty.	Price
CLS-1437-A10	1	\$167.40 ♥

Sparger Assemblies, 3-Port, SST, with Hose Barbs and Frits

Our 3-port sparger assemblies are designed for gentle aeration using a 10 micron frit in our vertical side arm (VSA) vessels. The frit is removable for easy cleaning. These assemblies are constructed of 316L stainless steel, electro-polished to a 20Ra finish or better and include a blue polypropylene GL-45 open top cap and white silicone gasket.

3-Port Sparger Assemblies with Frits

Part No.	Fits Vessel	Qty.	Price
CLS-1437-F50	3L VSA	1	\$752.80 ♥
CLS-1437-F51	6L VSA	1	\$769.40 ♥
CLS-1437-F52	8L VSA	1	\$802.90 ♥
CLS-1437-F53	15L VSA	1	\$819.50 ♥
CLS-1437-F54	36L VSA	1	\$836.30 ♥

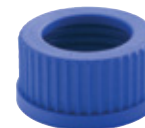

CLS-1437-F-series Sparger Assemblies





CLS-1437-H-series Sparger Assemblies



CLS-1437-G1



CLS-1408-series

Sparger Assemblies, 3-Port, SST, with Hose Barbs and Holes

Our 3-port sparger assemblies with drilled holes, 0.040" spaced 1/2" apart, and hose barbs are designed for vigorous aeration in our vertical side arm (VSA) vessels. These assemblies are constructed of 316L stainless steel, electro-polished to a 20Ra finish or better and include a blue polypropylene GL-45 open top cap and white silicone gasket.

3-Port Sparger Assemblies with Holes

Part No.	Fits Vessel	Qty.	Price
CLS-1437-H40	3L VSA	1	\$339.70 ♥
CLS-1437-H41	6L VSA	1	\$351.30 ♥
CLS-1437-H42	8L VSA	1	\$384.90 ♥
CLS-1437-H43	15L VSA	1	\$401.40 ♥
CLS-1437-H44	36L VSA	1	\$418.10 ♥

Glass Frits

Made of glass and easily attaches to one of our dip tube assemblies with silicone tubing (not provided) to help increase aeration. Porosity is 40-60 micron. Can be autoclaved. Frit assembly 50mm. Stem OD 8mm.

Glass Frit

Part No.	Porosity (µm)	Qty.	Price
CLS-1437-G1	40-60	1	\$83.80 ♥

Heating Blankets, Bioreactors and Spinner Flasks

Our heating blankets are available in a variety of sizes for use with our spinner flask and bioreactor vessel lines. A male IEC connector is provided for easy connection to either modular temperature controller or our Celltrol II control system. Vessel must be stirred when heating blankets are in use, heating at 5 watts per square inch.

Heating Blankets for Bioreactors and Spinner Flasks

Part No.	Description	Watts	Dims. (in.)	Qty.	Price
CLS-1408-010	500mL	50	1" x 10.5"	1	\$372.10 *
CLS-1408-020	1L	75	1" x 14"	1	\$372.10 *
CLS-1408-060	3L/P, 6L/P, 8L	375	3" x 26.5"	1	\$465.25 *
CLS-1408-070	15L	325	5" x 33"	1	\$558.20 *
CLS-1408-085	36L	200	5" x 48"	1	\$702.05 *
CLS-1408-090	36L	375	5" x 48"	1	\$702.05 *

*Life Science Equipment Product Line

DISCOUNT KEY: * Not Subject to Discount. † Reusable Glass. ♣ Celltreat / Consumable LM Products.

DO Probes, Hamilton

The Oxyferm FDA is an electrochemical oxygen sensor suited for applications with high demands for hygiene, e.g. in pharmaceutical industry, in biotechnology and in foods and beverages production. When using Oxylyte USD electrolyte, even upside-down insertion is possible. The sensor is equipped with a FDA approved membrane for usage in hygienic processes.

Specifications

Electrode System	Silver Platinum Combination
Polarization	670mV ± 50mV
Output	40 to 80nA in Air at 25°C
Temperature	0-130°C, Sterilization to 130°C
Drift at Room Temp under Constant Conditions	Drift at Room Temp under Constant Conditions: <1% per Week
Stabilization Time	Pressure: 0-4 Bar
Wetted Materials	Stainless Steel 1.4435, EPDM and Silicone with FDA Approval
Mounting	PG 13.5 Thread
Electrical Connector	Standard 4 Pole T 82/D4

DO Probes, Oxyferm FDA

Part No.	Dims. (mm)	Connector	Qty.	Price
CLS-1435-D70	12 x 120	Standard 4 Pole T82/D4	1	Call *
CLS-1435-D72	12 x 235	Standard 4 Pole T82/D4	1	Call *
CLS-1435-D73	12 x 320	Standard 4 Pole T82/D4	1	Call *
CLS-1435-D74	12 x 420	Standard 4 Pole T82/D4	1	Call *
CLS-1435-D80	12 x 120	VP	1	Call *
CLS-1435-D82	12 x 225	VP	1	Call *
CLS-1435-D83	12 x 325	VP	1	Call *
CLS-1435-D84	12 x 425	VP	1	Call *

Accessories for DO Probes, Oxyferm FDA

Part No.	Description	Qty.	Price
CLS-1435-D88	Oxyferm Membrane Kit (Pack of Three)	1	Call *
CLS-1435-D90	Cathode Assembly for Oxyferm DO Sensors	1	Call *
CLS-1435-D91	Electrolyte for Oxyferm FDA Sensors, 50mL	1	Call *
CLS-1435-D92	Protective Cap for T82 DO Sensor Autoclaving	1	Call *



CLS-1435-D70



CLS-1435-D80



CLS-1435-P-series

pH Probes, Hamilton

The Easyferm Plus K8 sensors are designed to withstand demanding applications in pharmaceutical and chemical industries. The EVEREF-F reference cartridge ensures that the Phermlyte reference electrolyte remains free of silver and precipitation. The Easyferm Plus K8 is supplied with a pre-sterilized electrolyte which prevents the diffusion of sample into the sensors. It withstands steam sterilization, autoclaving, CIP, organic solvents and strong acids. Fully autoclavable or in-situ sterilizable.

Specifications

pH Range	0-14
Electrolyte	Pressurized PHERMLYTE
Pressure Range	0-6 Bar
Electrical Connector	Type K8 - Standard pH Connector Head or VP
Reference System	HAMILTON EVEREF-F, Silver ion barrier included
Temperature Range	Steam Sterilizable/Autoclavable to 266°F (0 to 135°C)
IN-situ Sterilization	Up to 100 Cycles under Standard Conditions

Easyferm Plus K8 pH Probes

Part No.	Dims. (mm)	Connector	Qty.	Price
CLS-1435-P70	12 x 120	K8	1	Call *
CLS-1435-P71	12 x 200	K8	1	Call *
CLS-1435-P72	12 x 225	K8	1	Call *
CLS-1435-P73	12 x 325	K8	1	Call *
CLS-1435-P74	12 x 425	K8	1	Call *
CLS-1435-P76	12 x 120	VP Connector	1	Call *
CLS-1435-P77	12 x 225	VP Connector	1	Call *
CLS-1435-P78	12 x 325	VP Connector	1	Call *
CLS-1435-P79	12 x 425	VP Connector	1	Call *

Probe Holders

Our probe holders are designed to secure pH and DO probes into 45mm vertical sidearm vessels. Includes thermoplastic, polyester cap and silicone gasket. This assembly is designed to hold an Ingold pH or DO electrode securely in place in your cell culture vessel via the 45mm sidearm. It consists of: red high temperature 45mm screw cap, 316L SST probe holder with a Pg 13.5 thread, and a white silicone rubber liner. Comes fully assembled for fast and easy set-up.

Probe Holders

Part No.	Description	Qty.	Price
CLS-1437-01	12mm GL-45, PG 13.5 Screw Thread Style	1	\$326.20 ♥
CLS-1437-02	12mm GL-45, Compression Style	1	\$184.10 ♥
CLS-1437-03	1/2" GL-45, Compression Style	1	\$184.10 ♥

Accessories

Part No.	Description	Qty.	Price
CG-195-05	GL-45 Cap with 34mm Aperture	1	\$6.00 ♥
CLS-1428-11	Replacement Open GL-45 White FDA Silicone Gasket Only for Port Assembly	1	\$3.00 ♥



DISCOUNT KEY: * Not Subject to Discount. † Reusable Glass. ♣ Celltreat / Consumable LM Products.

Shaker Rack for 50mL Bioreaction Tubes

- Stainless steel construction
- Angle adjustment of up to 30°
- Silicone gasket holds tubes securely
- Can be used with skirted or standard tubes
- Fits all shakers with a top plate of at least 14" x 14"

Our unique 49-position shaker rack for 50mL bioreaction tubes is an ideal platform for high throughput experiments for screening and process optimization. The rack allows the tubes to be placed at an optimum angle (up to 30°) for both oxygenation and finding the correct fluid motion, eliminating the need for excess agitation. The silicone insert secures the tubes in the rack and prevents damage to the tubes and rotational slippage.

Rack supplied with four attached pegs which fit directly into the top of **CLS-4021-100 Orbital shaker**. Can also be used with other orbital shakers using **CLS-4008-T03** double faced tape. *Purchase tubes separately.*



CLS-4285-R1

**Shaker Rack Shown on
Optional Versa-Orb Orbital
Shaker, CLS-4021-100**

Tilting Shaker Rack for 50mL Bioreaction Tubes

Part No.	Positions	Qty.	Price
CLS-4285-R1	49	1	\$913.10 *

*Life Science Equipment Product Line

Sterile, Bio-Reaction Centrifuge Tubes, 50mL, NEST

- USP VI polypropylene tubes with HDPE caps
- Packaged in sterile, zip-sealable bags
- Non-pyrogenic, non-cytotoxic, DNase- and Rnase-free, human DNA-free

Bio-reaction tubes offer a convenient and economical option for suspension cell culture. Bio-reaction tubes include vent caps for gas exchange; 0.22µm hydrophobic membranes are welded in. These tubes provide an environment perfect for small scale suspension culture or biological reaction experiments that require aseptic conditions with free gas exchange. Bio-reaction tubes are extremely useful in the screening and optimization processes of suspension cells. Reaction parameters can be optimized with small amounts of material which can maximize the number of parallel experiments that can be done.



**Graduations,
marking spots
and vented caps**

CGN-4285-050

Sterile Bio-Reaction Centrifuge Tubes

Part No.	Cap. (mL)	Qty.	Reg. Price	SALE Price
CGN-4285-050	50	100	\$145.50	\$116.40 ♣

Sticky Pads - An ideal alternative to flask clamps.

Great for securing containers with flat wide bases to shaker platforms especially those that cannot be held with traditional clamps. With shake flasks the pad can be used at speeds up 200 or 300 rpm (see chart below), from -30 to 70°C. It can be regenerated for reuse by simply washing with mild detergent and water. Sticky Pad cannot be used in water baths. Contact us about special, smaller sizes.

Sticky Pad

Part No.	Dimensions	Qty.	Price
CLS-4010-16	15-3/4 x 19-1/2" (400 x 500mm)	1	\$278.70 *



CLS-4010-16

♥ Bioreactor Reactor Discount. ■ Spinner Flasks and Accessories. ◇ Life Sciences Consumables.

N-BIOTEK Incubators

ADVANCED
technology

outstanding quality

Reliability



See Part No. series'
CLS-2451 through
CLS-2456.



Engineered for Today's Cell Culture Requirements

- CO₂ Incubators
- SHAKING Incubators
- CO₂ SHAKING Incubators
- REFRIGERATED Incubators (vertical type)
- GENERAL Incubators
- HYBRIDIZATION Incubators

● ● ● ● ● See complete details online www.cglifesciences.com

DISCOUNT KEY: * Not Subject to Discount. † Reusable Glass. ♣ Celltreat / Consumable LM Products.

Bottles, Media Storage, Duran®

Heavy duty bottle which can be used for storage as well as mixing and sampling. Bottle available with closure which includes liner-less, one-piece autoclavable polypropylene plug seal cap with drip free pouring rings, or without closures in both clear and amber (For amber see CLS-1175). Optional red PBT caps and red ETFE pouring rings are available for dry heat sterilization (180°C). Glass bead indicates full capacity line on 100mL through 2L size. Bottles have permanent white enamel graduations and marking spots. Solid, color-coded polypropylene caps in a choice of orange, green, purple, red, and light gray are available. Open-top caps and PTFE/Silicone septa are also available.

Media Storage Bottles			Bottles With Blue Caps		Bottles Only (No Caps)	
Cap. (mL)	Thread Size	Qty.	Part No.	Price	Part No.	Price
25	GL-25	10	CLS-1172-25	\$140.90 †	CLS-1174-25	\$99.60 †
50	GL-32	10	CLS-1172-50	\$140.90 †	CLS-1174-50	\$99.60 †
100	GL-45	10	CLS-1172-100	\$147.00 †	CLS-1174-100	\$96.30 †
250	GL-45	10	CLS-1172-250	\$169.90 †	CLS-1174-250	\$119.10 †
500	GL-45	10	CLS-1172-500	\$212.40 †	CLS-1174-500	\$161.60 †
1,000	GL-45	10	CLS-1172-1L	\$302.70 †	CLS-1174-1L	\$249.00 †
2,000	GL-45	10	CLS-1172-2L	\$703.00 †	CLS-1174-2L	\$652.40 †
5,000	GL-45	1	CLS-1172-5L	\$295.70 †	CLS-1174-5L	\$290.50 †
10,000	GL-45	1	CLS-1172-10L	\$373.60 †	CLS-1174-10L	\$542.40 †
15,000	GL-45	1	—	—	CLS-1174-15L	\$750.90 †
20,000	GL-45	1	CLS-1172-20L	\$1,160.70 †	CLS-1174-20L	\$1,136.30 †



CLS-1172-series



CLS-1174-series

CAUTION: Bottles larger than 2L should NOT be used with bottle top filter units, or in other applications involving vacuum pressure, as breakage may occur. DO NOT have caps tightened immediately after autoclaving as the vacuum resulting from cooling can cause breakage. A pouring ring is not included on 25mL size. A vented cap is NOT recommended for use on the 5L and 10L bottle.

Multipurpose Versa-Orb Digital Orbital Shakers

Built for versatility and performance, this multipurpose shaker base features a space-saving, low-profile design ideal for agitation of gels, staining, de-staining and assay development. The peg-and-grommet-type top plate accepts a variety of easily installed trays and is compatible with similar trays on the market. Speed, controlled by a rotary knob with convenient locking ring, is adjustable from 10 to 350rpm and is indicated in a bright, digital display. The shaker boasts a 1-inch orbit and a maximum load of 25lbs. Low-maintenance, 24V DC brushless motor features a detachable power supply. Two-year warranty included. **Trays with liners are sold separately.**

Versa-Orb Orbital Shaker Bases - Order Trays Separately

Part No.	Description	Qty.	Price
CLS-4021-100	Digital Base Only, 120V	1	\$3,159.90 *

Trays

Part No.	Description	Qty.	Price
CLS-4021-1212	Aluminum Tray with Liner, 12" x 12"	1	\$121.70 *
CLS-4021-1515	Aluminum Tray with Liner, 15" x 15"	1	\$160.70 *
CLS-4021-2020	Aluminum Tray with Liner, 20" x 20"	1	\$177.10 *
CLS-4021-2030	Aluminum Tray with Liner, 20" x 30"	1	\$418.20 *



- One-inch orbit, 10 to 350rpm range
- Digital speed display
- Two-year warranty

See complete specifications on the web at www.cglifesciences.com



CLS-1480-series

Caps, Solid, GL-Threads, Polypropylene

Solid polypropylene caps with a molded in lip seal. All color caps can be autoclaved in steam to 140°C.

Solid Top, Polypropylene Caps, Colors

Part No.	Thread Size	Color	Qty.	Price
CLS-1480-10	GL-25	blue	10	\$32.50 ◇
CLS-1480-11	GL-32	blue	10	\$32.50 ◇
CLS-1480-12	GL-32	orange	10	\$35.45 ◇
CLS-1480-13SC	GL-45, Schott	blue	10	\$38.50 ◇
CLS-1480-14	GL-45	gray	10	\$40.50 ◇
CLS-1480-15	GL-45	green	10	\$38.50 ◇
CLS-1480-16	GL-45	orange	10	\$38.80 ◇
CLS-1480-17	GL-45	purple	10	\$40.50 ◇
CLS-1480-18	GL-45	yellow	10	\$38.50 ◇



CLS-1482-series

Pouring Rings, Polypropylene, Ethylene Tetrafluoroethylene

Steam autoclavable to 140°C. All pouring rings are polypropylene except for the CLS-1482-30 which is made of high temperature ETFE (ethylene tetrafluoroethylene); max temp is 180°C.

Pour Rings, Colors

Part No.	Thread Size	Material	Color	Qty.	Price
CLS-1482-11	GL-32	PP	blue	10	\$14.20 ◇
CLS-1482-12	GL-32	PP	clear	10	\$14.60 ◇
CLS-1482-13	GL-45	PP	blue	10	\$15.90 ◇
CLS-1482-14	GL-45	PP	green	10	\$18.10 ◇
CLS-1482-15	GL-45	PP	gray	10	\$18.10 ◇
CLS-1482-16	GL-45	PP	yellow	10	\$18.10 ◇
CLS-1482-17	GL-45	PP	clear	10	\$14.50 ◇
CLS-1482-30	GL-45	ETFE	red	10	\$40.50 ◇



CLS-1481-series

Caps, Open Tops, GL-Threads, Polypropylene

Open top polypropylene caps for use with port assemblies. Caps can be autoclaved in steam to 140°C.

Open Top, Polypropylene Caps, Colors

Part No.	Thread Size	Hole Dia. (in)	Color	Qty.	Price
CLS-1481-20	GL-32	13/16"	blue	6	\$42.90 ♥
CLS-1481-21	GL-45	1-5/16"	blue	6	\$51.50 ♥
CLS-1481-22	GL-45	1-5/16"	green	6	\$51.50 ♥
CLS-1481-23	GL-45	1-5/16"	yellow	6	\$51.50 ♥

DISCOUNT KEY: * Not Subject to Discount. † Reusable Glass. ♣ Celltreat / Consumable LM Products.

Caps, Solid, Clear, GL-45 Threads, TpCH260, PTFE-Coated Silicone Seals, USP Class VI

These premium clear caps are made from TpCh260 (similar to PFA) with PTFE coated silicone seals. Material TpCh260 is compliant to USP Class VI. Premium cap compound is formulated without color dye to avoid risk of leaching. Premium caps can be used in temperatures from -196° to 260°C.

Solid Top, TpCh260 Caps with PTFE-coated Silicone Seals

Part No.	Thread Size	Material	Color	Qty.	Price
CLS-1480-19	GL-45	TpCh260	clear	5	\$180.60 ◇



CLS-1480-19

Caps, Solid, Clear, GL-45 Threads, PFA 6515 TZ, Lip Seals, USP Class VI

These premium clear caps are made from fluoropolymer (PFA 6515 TZ) with lip molded seals. Material PFA 6515 TZ is compliant to USP Class VI. Premium cap compound is formulated without color dye to avoid risk of leaching. GL-45 caps can be used in temperatures from -196° to 260°C.

Solid Top, PFA 6515 TZ Caps with Lip Seals

Part No.	Thread Size	Material	Color	Qty.	Price
CLS-1480-20	GL-45	PFA 6515 TZ	clear	5	\$267.70 ◇



CLS-1480-20

Caps, Vented, Polypropylene, Non-Sterile, GL-45

Polypropylene vented cap has a 0.22µm (PTFE) hydrophobic membrane to allow gas exchange while preventing contamination. They have a liner-less plug seal design for efficient sealing. They are autoclavable at 121°C.

Vented, Polypropylene Caps, Non-Sterile

Part No.	Thread Size	Material	Color	Qty.	Price
CLS-1484-10	GL-45	PP	gray	1	\$6.25 ◇



CLS-1484-10

Caps, Vented, Polypropylene, Non-Sterile, GL-45

Polypropylene vented cap has a 0.20µm (ePTFE) hydrophobic membrane combined with larger vent holes to increase the rates of gas exchange while preventing contamination. They have a liner-less plug seal design for efficient sealing and are autoclavable at 121°C.

Vented, Polypropylene Caps, Non-Sterile

Part No.	Thread Size	Material	Color	Qty.	Price
CLS-1484-12	GL-45	PP	blue	5	\$54.80 ◇

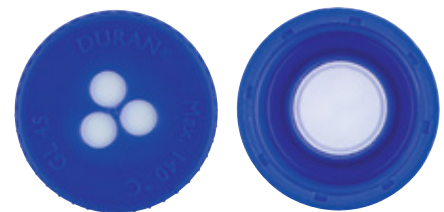

CLS-1484-12

Caps, Vented, Polypropylene, Non-Sterile, GL-45

Polypropylene vented cap has a 0.22µm (PTFE) hydrophobic membrane to allow gas exchange while preventing contamination. They have a liner-less plug seal design for efficient sealing. They are autoclavable at 121°C.

Vented, Polypropylene Caps, Non-Sterile

Part No.	Thread Size	Material	Color	Qty.	Price
CLS-1484-B-45	GL-45	PP	blue	5	\$60.70 ◇



CLS-1484-B-45

Port Assemblies, 2-Port, SS, with Hose Barbs

Our 2-port dip tube assemblies are designed for addition or sampling of media from standard Duran or Corning® media bottles. They are constructed of 316L electropolished stainless steel and include a blue polypropylene GL45 open top cap with a white silicone gasket. Dip tube assemblies have a finish of 20Ra or better.

Two-Port Assemblies

Part No.	Fits Vessels	Qty.	Price
CLS-1437-19	1L Media Bottles Only	1	\$217.50 ♥
CLS-1437-20	3L VSA Vessels and 2L Media Bottles	1	\$225.80 ♥
CLS-1437-21	6L VSA Vessels and 5L Media Bottles	1	\$259.30 ♥
CLS-1437-22	8L VSA Vessels and 10L Media Bottles	1	\$301.10 ♥
CLS-1437-23	15L & 36L VSA Vessels Only	1	\$333.00 ♥

Port Assemblies, 3-Port, SS, with Hose Barbs

Our 3-port assemblies are designed for addition or sampling of media from standard Duran or Corning® media bottles. They are constructed of 316L electropolished stainless steel and include a blue polypropylene GL45 open top cap with a white silicone gasket. Dip tube assemblies have a finish of 20Ra or better.

Three-Port Assemblies

Part No.	Fits Vessels	Qty.	Price
CLS-1437-29	1L Media Bottles Only	1	\$276.10 ♥
CLS-1437-30	3L VSA Vessels and 2L Media Bottles	1	\$284.50 ♥
CLS-1437-31	6L VSA Vessels and 5L Media Bottles	1	\$301.10 ♥
CLS-1437-32	8L VSA Vessels and 10L Media Bottles	1	\$317.90 ♥
CLS-1437-33	15L & 36L VSA Vessels Only	1	\$376.40 ♥

CLS-1437-series
2-Port Assemblies



CLS-1437-29
(Bottle not included.)

CLS-1437-series
3-Port Assemblies



Media Bottles with Siphon Assembly

Standard media bottle with siphon assembly consisting of stainless steel siphon pipe and silicone tubing cut to length. All stainless parts are manufactured from 316L stainless steel electropolished to a 20Ra or better finish. The silicone tubing is peroxide cured and meets 21 CFR 177.2600 material specifications.

Assembled, the media bottle with siphon assembly allows the user to create precisely the desired dip tube angle to retrieve virtually all of the contents of fluid from the bottle.

Media Bottles with Siphon Assemblies

Part No.	Capacity (mL)	Qty.	Price
CLS-1420-250	250	1	\$406.40 ♥
CLS-1420-500	500	1	\$409.80 ♥
CLS-1420-1L	1,000	1	\$416.60 ♥
CLS-1420-2L	2,000	1	\$444.00 ♥
CLS-1420-5L	5,000	1	\$607.80 ♥
CLS-1420-10L	10,000	1	\$716.90 ♥



CLS-1420-series

DISCOUNT KEY: * Not Subject to Discount. † Reusable Glass. ♣ Celltreat / Consumable LM Products.

High Volume, Digital, Magnetic Stirrers

High Volume magnetic stirrer has a bright digital display to accurately set the stirring speed. SpeedServo™ ensures constant speed even when the viscosity changes. Magnetic stirrers have been designed and manufactured in compliance with the following standards CE, CSA and UL. The MSL Series is designed for high volume stirring/mixing of water-like solutions. Main Applications: High volumes preparations, cell cultures and tissue cultures (with spinner flasks), buffer solution preparations.

Versatility

- Brushless motors provide continuous operation for high volumes at any speed
- Clear, white number, LCD displays ensure accurate speed settings

Safety

- Gentle start and low speed stirring (20rpm) to protect your samples
- The control panel is protected from liquid spills
- Stainless-steel covers allow easy visualization of particles and color changes
- Safety locks avoid possible unintentional changes
- Designed for long lifespan and guaranteed by 3-year warranty

Exclusive Performance

- SpeedServo™ technology maintains constant speed
- Programmable operation thanks to the integral timer (1 to 99 min)
- Auto reverse of the stirring direction (5s to 99min55s)
- Intermittent mode option enhances programming capabilities to match any application
- Nemko mark indicates compliance with CSA and UL standards



High Volume, Digital Magnetic Stirrers, 50-60hz, 100-240V

Part No.	Stirring Volume, H ₂ O (L)	Speed Range (rpm)	Dimensions, W x H x D (mm)	Qty.	Price
CLS-4108-08	8	40-1500	168 x 60 x 183	1	\$437.00 *
CLS-4109-25	25	40-1500	253 x 71 x 269	1	\$940.00 *
CLS-4110-50	50	20-1000	354 x 77 x 369	1	\$2,412.00 *

See complete details online

www.cglifesciences.com





**Stackable,
Space-Saving
Design**



Large Capacity CO2 Incubator Shakers feature Temperature, Shaking, CO2 Concentration, and Humidity controls. Its stackable design helps maximize floor space, with the capability to stack up to three units high.

See our website for more information and complete specifications.

LARGE CAPACITY Stackable Incubator Shaker with CO2 Controller and Touch Screen

High Resolution, 7-inch, Capacitive Touch Screen

- Clear, concise instrument status and functions
- Responsive and durable

Large Capacity Chamber (190L Volume)

- Hold up to six, 5L Erlenmeyer shaker flasks

Convenient Pull Out Rail Platform Operation

- Single, centrally-located locking handle

Excellent Temperature Control Performance

- At a stable temperature of 37 °C, the uniformity is ± 0.2 °C

Chamber Cooling Capacity to 20°C Below Ambient

- Lowest temp is 4 °C

Energy-Saving Inverter Compressor

- Makes cooling a noiseless, durable, and highly efficient

Three Units Can Be Stacked

- Purchased as a single, double or triple stack

Bi-Directional UV Light Sterilization

- Two sets of components reach all areas of the chamber

Ultra-Quiet Design

- Noise level less than 55dB when incubator is running and cooling (loudest process)

Slow Acceleration / Deceleration

- Prevents large shear forces on the bacteria or cells

High Pressure Water Rinse - Fast and Efficient

- Integral drain system for platform and chamber



Part No.	Description	Price
CLS-2545-011	Single	call
CLS-2545-012	Double	call
CLS-2545-013	Triple	call

DISCOUNT KEY: * Not Subject to Discount. † Reusable Glass. ♣ Celltreat / Consumable LM Products.

COMPACT Stackable Incubator Shaker with Magnetic Drive and CO2 Controller and Touch Screen



See our website for more information and complete specifications.

Single Unit Dimensions

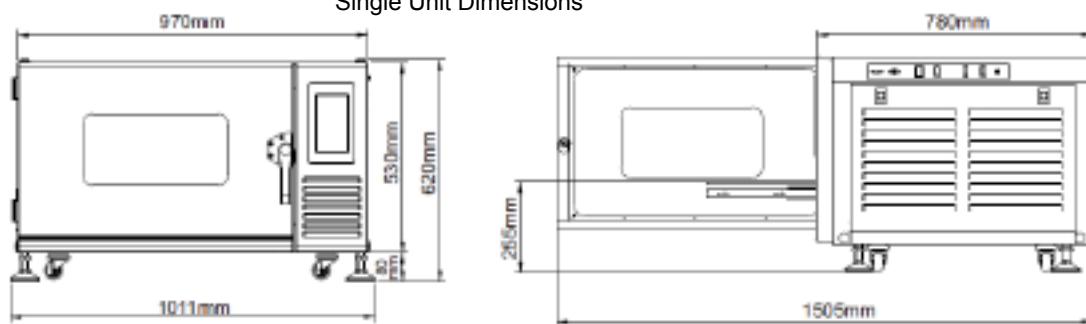

COMPACT Stackable Incubator Shaker with Magnetic Drive and CO2 Controller

- **Magnetic Drive Motor** - more reliable, low maintenance
- **Stackable, Space-Saving Design** - up to 3 levels
- **Triple Eccentric Drive**
- **Large LCD Color Display Control Panel** - 7 inches
- **Built-in Humidity Box**

Part No.	Description	Price
CLS-2542-011	Single, 190L	call
CLS-2542-012	Double, 190L	call
CLS-2542-013	Triple, 190L	call

♥ Bioreactor Reactor Discount. ■ Spinner Flasks and Accessories. ◇ Life Sciences Consumables.



Chemglass Life Sciences supports your bioprocess with a multitude of standard and custom single-use product configurations.

Contact us with your single-use needs:

T 1.800.843.1794

F 1.800.922.4361

www.cglifesciences.com

tech@cglifesciences.com

customer-service@cglifesciences.com

CG-24004TAC3M0124 ©2024 Chemglass Life Sciences. Printed in USA. Trademarks are the property of their respective owners. **Prices subject to change without notice.**

