

# CELLathon 2024

T 800.843.1794

F 800.922.4361

[www.cglifesciences.com](http://www.cglifesciences.com)

[cs@cglifesciences.com](mailto:cs@cglifesciences.com)



### Why we're right for you.

#### Manufacturing Experience

- Leading scientific glassware manufacturer for more than 75 years
- Most glass process reactor expertise in the industry

#### Quality Products in Stock

- 12,000+ standard chemistry and life sciences products
- In stock and ready to ship

#### Superior Customer Care

- Prompt, courteous and efficient customer service
- Dedicated technical service representatives
- Technical assistance for custom and oem glass

#### Balances and Weighing

Mini Balances .....	3
Weighing Dishes / Boats .....	4-5
Spatulas, Spoons, Scoops .....	5-6

#### Cell Culture

Dishes .....	7
Flasks .....	7-10
Plates .....	10
Strainers .....	11
Cryogenic Vials .....	11
Electroporation Cuvettes .....	12
Hemocytometer .....	12

#### Cell and Tissue Culture

Dishes, Glass Bottom .....	13
Plates .....	13
Bio-Reaction Tubes .....	14
Scrapers .....	14

#### Drosophila

Bottles, Vials and Plugs .....	15
--------------------------------	----

#### Electrophoresis

Mini-Run System .....	16
Gel Band Cutters .....	16
Staining Solution .....	16
Agarose LE .....	17

#### Equipment

Autoclaves .....	18-19
Dry Bath .....	20
Microcentrifuges .....	20-22
Mini Centrifuges .....	23
BeadBath Duo .....	24
Lab Armor Beads .....	24
Mixers / Vortexers .....	25
Magnetic Stirrers .....	26

#### Filtration

Bottle Top Filter System .....	27
Vacuum Filtration Pump .....	27
Syringe and Syringe Filters .....	28

#### General Labware

Beakers .....	29
Bottles and Carboys .....	29-31
Cylinders .....	32
Erlenmeyer Flasks .....	33
Transfer Forceps .....	33
Freezer Boxes and Racks ...	34-35
Gloves .....	36
Absorbent Liner .....	37
Ice Buckets .....	37
Laboratory Labeler / Printer .....	38
Sealing Film .....	39-41
Autoradiography Film .....	42
Colony Counter .....	42
Spill Trays .....	43
Stir Bars .....	44
Tape, Labeling .....	45-46

#### Liquid Handling

Fluid Aspirator Systems .....	47
Micropipettes .....	48, 52-53
Pipette Tips .....	50-51, 54-55
Pipette Stands .....	50-51
Pipette Controllers .....	56
Serological Pipettes and Rack ..	57
Reagent Reservoirs .....	49
Transfer Pipettes .....	58

#### Microbiology

Petri Dishes .....	59
Spreaders / Loops .....	59-60
Picks .....	61

#### Microscopy

Slides .....	61-62
Cover Slips .....	62-63

#### PCR

Wellplates and Strips .....	64
-----------------------------	----

#### Tubes

Microcentrifuge .....	65
Centrifuge .....	66-69
Transport .....	70
Flowtubes .....	71



Trademarks are the property of their respective owners. **Prices are subject to change without notice.** Copyright 2024 Chemglass Life Sciences. Printed in USA.

\* Lab Supply Prod. Line ♦ Life Sciences Consumable Prod. Line

## Lab Mini Balances, 100G and 500G

- Easy-to-read, backlit LCD
- Calibration function
- Includes batteries and a snap-on, protective cover
- Compact - less than 3" wide

Accuris Mini Balances are compact, easy to use and convenient for a variety of weighing applications. With a footprint of only 2.6 x 3.9 inches, these Mini Balances offer exceptional accuracy and linearity through their full weighing ranges.

Available with either a 100g or 500g capacity, these digital balances feature an easy to read, backlit, liquid crystal display. Buttons for ON/OFF, MODE and TARE are located on the front for easy access. The software includes a calibration function for in-lab calibration with a 100g or 500g calibration weight. Calibration weights are available separately.

Portable Accuris Mini Balances are powered by 2 AAA batteries (included). After one minute sitting idle, the power automatically shuts off to conserve battery life. Ideal for lab or field use, each includes a snap on, protective cover with instructions conveniently printed on the underside. Ninety-day warranty included.

Max. Capacity (g)	100	500
Readability (g)	0.01	0.01
Repeatability (g)	0.01	0.01
Linearity (+/-g)	0.01	0.01
Calibration	external	external
Pan Size (in)	2.1 x 2.25	2.1 x 2.25
Weighing Units	g, ct, dwt, gn	g, ct, dwt, gn
Display	backlit LCD	backlit LCD
Power	AAA batteries (2)	AAA batteries (2)
Exterior Dims.	2.6 x 3.9 x 0.75	2.6 x 3.9 x 0.75



CG-793-series

### Accuris Mini Lab Balances

Part No.	Max. Weight (g)	Footprint Size (in)	Qty.	Price
CG-793-100	100	2.6 x 3.9	1	\$50.70 *
CG-793-500	500	2.6 x 3.9	1	\$45.20 *

BALANCES TO  
FIT YOUR NEEDS

COMPACT

PRECISION

ANALYTICAL

See our website for the complete  
line of New and Classic ACCURIS  
Balances and Accessories

[www.cglifesciences.com/balances](http://www.cglifesciences.com/balances)



† Reusable Glass / Plastics Prod. Line ♣ Consumable Prod. Line Ω EDU / Economical Pkg. Prod. Line

[tech@cglifesciences.com](mailto:tech@cglifesciences.com) • [customer-service@cglifesciences.com](mailto:customer-service@cglifesciences.com)



Square CLS-1815-series

### Weighing Dishes, Square, Anti-Static, Polystyrene

The polystyrene weighing dishes will resist diluted acids, aqueous solutions, alcohols and bases. They are ideal for weighing, dispensing or storing both liquid and powdered samples. They afford accurate pour-outs with minimal sample loss and can also be used as quick freeze trays for sample material. Dishes will withstand temperatures up to 80°C.

#### Polystyrene, Anti-static, Square Weighing Dishes

Part No.	Cap. (mL)	L x W x H (mm)	Qty.	Price
<b>CLS-1815-001</b>	10	40 x 40 x 8	500	<b>\$90.05</b> ◇
<b>CLS-1815-002</b>	100	78 x 78 x 25	500	<b>\$119.30</b> ◇
<b>CLS-1815-003</b>	300	127 x 127 x 25	500	<b>\$236.30</b> ◇



Pour Boat CLS-1815-series

### Weighing Dishes, Pour Boat, Anti-Static, Polystyrene

Three sizes of weighing dishes have a pour spout that facilitates dispensing of powdered and liquid materials. Smooth, uniform and economical, the molded material is 20 to 30% thicker than conventional weigh dishes. Dishes can withstand temperatures up to 80°C. They can be used safely to weigh static-affected materials.

#### Polystyrene, Anti-static, Pour Boat, Dishes

Part No.	Cap. (mL)	L x W x H (mm)	Qty.	Price
<b>CLS-1815-004</b>	12	50 x 37 x 8	250	<b>\$41.15</b> ◇
<b>CLS-1815-005</b>	140	128 x 76 x 25	250	<b>\$84.80</b> ◇
<b>CLS-1815-006</b>	270	180 x 117 x 25	250	<b>\$115.05</b> ◇



Hexagonal CLS-1815-series

### Weighing Dishes, Hexagonal, Anti-Static, Polystyrene

These dishes are excellent for handling solids or liquids during weighing. Dishes are easily bent into pouring spouts that enable non-spill transfer. The molded hexagonal design provides greater balance protection and safety. Not reactive with most substances. Dishes are suitable for weighing of static affected samples. They are stackable for easy storage and accessibility. Dishes will withstand temperatures up to 80°C.

#### Polystyrene, Anti-static, Hexagonal, Weighing Dishes

Part No.	Cap. (mL)	Top ID x Base ID x H (mm)	Qty.	Price
<b>CLS-1815-007</b>	9	35 x 25 x 10	500	<b>\$73.80</b> ◇
<b>CLS-1815-008</b>	58	70 x 47 x 20	500	<b>\$112.20</b> ◇
<b>CLS-1815-009</b>	203	115 x 85 x 22	500	<b>\$356.95</b> ◇
<b>CLS-1815-010</b>	355	130 x 95 x 30	500	<b>\$253.00</b> ◇



CG-1760-series

See weighing  
boats / funnels  
on the web.

\* Lab Supply Prod. Line ◇ Life Sciences Consumable Prod. Line

## SMARTBOAT™ Paper Weighing Boats

- Eco-Friendly
- Will naturally biodegrade
- Compatible with heat applications with a temperature limitation of 210°C
- Two sizes: small (3.5 x 3.5 x 1.5cm) and medium (4.5 x 4.5 x 1.5cm)
- Brown for light colored samples, white for dark samples

### Paper Weighing Boats

Part No.	Color	Size	Qty.	Price
CLS-1818-01	brown	small	500	\$36.65 *
CLS-1818-02	brown	medium	500	\$42.30 *
CLS-1818-03	white	small	500	\$36.65 *
CLS-1818-04	white	medium	500	\$42.30 *



Hexagonal CLS-1818-series

## Spatulas, Spoon, #300 Stainless Steel, Non-Magnetic

Spoon end will pass through a 19/22 outer joint, while the spatula end will pass through a 14/20 outer joint. Made of non-magnetic stainless steel with a mirror finish. Spoon end is 9/16in (14.3mm) wide x 1 1/4in (32mm) long and is excellent for use in transferring crystalline material. Spatula end is 5/16in (8mm) wide x 2in (51mm) long.

### Non-Magnetic, Spoon-Style Spatula

Part No.	Overall Length (in.)	Qty.	Price
CG-1985-14	9	1	\$10.50



CG-1985-14

## Lab Scoops, Stainless Steel

Scoop is designed with one pointed end and one blunt end. Design allows for digging out and handling of small amounts of material. Spatula is 6.5" OAL. Sold 6 per package.

### Straight Spatula with Pointed and Blunt Ends

Part No.	Overall Length (in.)	Qty.	Price
CG-1979-50	6.5	6	\$26.45

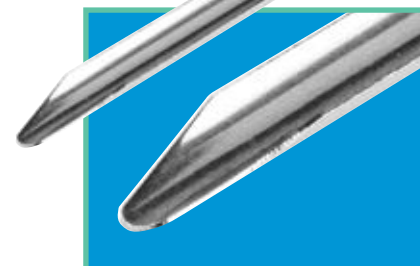

CG-1979-50

## Combination Spatula, Spoon and Scoop, Stainless Steel

Made entirely of Stainless Steel, this spatula has both a spoon and scoop. The spoon has a diameter of 26mm while the overall length of the spatula is 195mm. Sold 6 per package.

### Combination Spatula with Spoon and Scoop Ends

Part No.	Overall Length (mm)	Qty.	Price
CG-1979-80	195	6	\$39.70

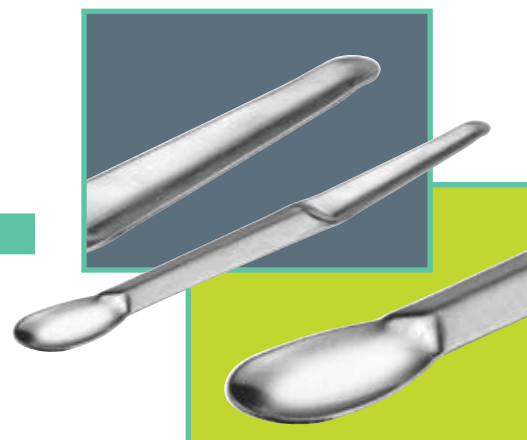

CG-1979-80

† Reusable Glass / Plastics Prod. Line ♣ Consumable Prod. Line Ω EDU / Economical Pkg. Prod. Line

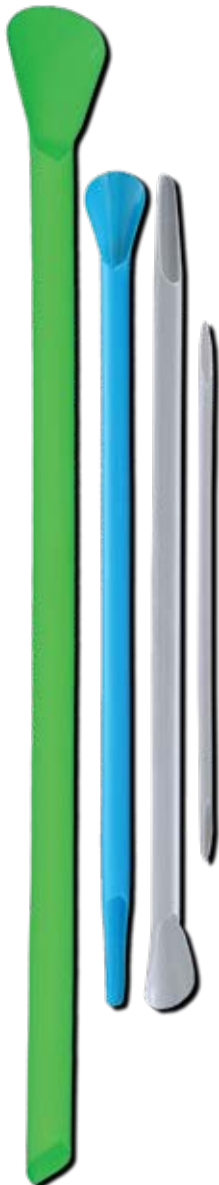

CG-1985-P-series

### Disposable SmartSpatulas®

- Inexpensive spatulas that scoop, scrape and stir
- Autoclavable for sterile applications
- Antistatic Micro for small volumes
- Unique hollow cores minimize thermal transfer
- Excellent for use as stir rod or policeman
- Resistant to dilute acids and bases
- Comply with FDA regulations for food-contact applications; made of virgin PP
- Shatter resistant for liquid nitrogen frozen samples

SmartSpatulas for laboratory sample handling and manipulation are an economic alternative to reusable spatulas. Made of virgin polypropylene, SmartSpatulas are autoclavable for sterile applications. Single-use, they help to reduce cross contamination, are resistant to dilute acids and bases. The unique hollow core minimizes thermal transfer.

SmartSpatulas comply with FDA regulations for food-contact applications, are shatter resistant for liquid nitrogen frozen samples and can also be used as stir rods or policemen.

### Polypropylene SmartSpatulas

Part No.	Description	Color	Length (mm)	Qty.	Price
CG-1985-P-01	Standard	blue	210	300	\$37.80 *
CG-1985-P-02	Standard	blue	210	7500	\$945.05
CG-1985-P-03	Standard	natural	210	300	\$37.80 *
CG-1985-P-04	Standard	natural	210	7500	\$945.05
CG-1985-P-05	Antistatic, Micro	natural	140	300	\$28.90 *
CG-1985-P-06	Antistatic, Micro	natural	140	7500	\$722.60
CG-1985-P-07	Macro	green	310	150	\$44.95 *
CG-1985-P-08	Macro	green	310	3600	\$1,077.65
CG-1985-P-10	SmartSpatula, STERILE	natural	210	100	\$133.05 *
CG-1985-P-12	SmartSpatula, STERILE	natural	210	500	\$623.50 *

### SmartSpatulas®



See a variety of  
ss spatulas on  
the web.

\* Lab Supply Prod. Line ◇ Life Sciences Consumable Prod. Line

## Cell Culture Dishes, Treated, Sterile, NEST

- Made from high clarity, 100% virgin polystyrene
- Stackable for easy storage and handling
- Flat transparent surface for distortion-free observation
- Sterilized by E-beam
- Vacuum plasma tissue culture treatment
- Clear lot number for batch traceability
- Non-Pyrogenic, DNase- and RNase-free

NEST cell culture dishes are ideal for all types of culturing where microscopic observation is required. Numeric marks on the bottom of each dish allow users to identify the location of cells.



CGN-1805-series

### NEST Sterile Cell Culture Dishes, Treated

Part No.	Size (mm)	Bag Qty.	Qty.	Price	SALE Price
CGN-1805-035	35	20	500	<del>\$119.50</del>	\$95.60 ♣
CGN-1805-060	60	20	500	<del>\$145.00</del>	\$116.00 ♣
CGN-1805-105	100	5	300	<del>\$178.00</del>	\$142.40 ♣
CGN-1805-100	100	20	300	<del>\$180.50</del>	\$144.40 ♣
CGN-1805-152	100 (with Gripping Ring)	20	300	<del>\$195.50</del>	\$156.40 ♣
CGN-1805-154	150	5	100	<del>\$182.50</del>	\$146.00 ♣

## Erlenmeyer Flasks with Vent Caps, Flat Base, Sterile, NEST

- PETG bottle with HDPE vent cap
- Ideal for shaker culture applications.
- Sterilized by E-Beam
- Non-pyrogenic
- Packaged in sterile bags
- Breathable membrane
- 0.22µm hydrophobic filter for gas exchange
- Non-toxic and environmentally friendly

### Erlenmeyer Flasks with Vent Caps

Part No.	Cap. (mL)	Cap Thread Size	OA Height (mm)	Qty.	Price	SALE Price
CGN-2092-125	125	34	107	24	<del>\$115.50</del>	\$92.40 ♣
CGN-2092-250	250	34	138	12	<del>\$79.50</del>	\$63.60 ♣
CGN-2092-500	500	34	176	12	<del>\$108.00</del>	\$86.40 ♣
CGN-2092-1000	1000	39	214	6	<del>\$90.00</del>	\$72.00 ♣



CGN-2092-series

† Reusable Glass / Plastics Prod. Line ♣ Consumable Prod. Line Ω EDU / Economical Pkg. Prod. Line

## Polycarbonate, Erlenmeyer Flasks with Caps, Sterile, NEST

Nest Erlenmeyer flasks are sterile, non-pyrogenic and manufactured with polycarbonate resin. Flasks are supplied complete with either seal caps or vent filter caps for anaerobic or aerobic applications. Solid caps are also ideal for applications requiring mixing, shaking and storage of biological fluids. Graduations are molded for accuracy. Flasks are sterilized by E-beam, SAL=10. Non-pyrogenic, DNase- and RNase-free. Individually packaged in sterile bags.

Flat Bottom,  
Erlenmeyer Flasks



### Flat Bottom, PC, Erlenmeyer Flasks with Seal Caps, Sterile

Part No.	Cap. (mL)	Cap Type	Qty.	Price	SALE Price
CGN-2090-125	125	seal	24	<del>\$122.00</del>	\$97.60 ♣
CGN-2090-250	250	seal	12	<del>\$83.50</del>	\$66.80 ♣
CGN-2090-500	500	seal	12	<del>\$122.50</del>	\$98.00 ♣
CGN-2090-1000	1,000	seal	6	<del>\$92.50</del>	\$74.00 ♣

### Flat Bottom, PC, Erlenmeyer Flasks with Vent Filter Caps, Sterile

Part No.	Cap. (mL)	Cap Type	Qty.	Price	SALE Price
CGN-2094-125	125	vent filter	24	<del>\$122.00</del>	\$97.60 ♣
CGN-2094-250	250	vent filter	12	<del>\$91.00</del>	\$72.80 ♣
CGN-2094-500	500	vent filter	12	<del>\$128.00</del>	\$102.40 ♣
CGN-2094-1000	1,000	vent filter	6	<del>\$98.50</del>	\$78.80 ♣

Quadruple-baffled  
Erlenmeyer Flasks



### Baffled Bottom, PC, Erlenmeyer Flasks with Seal Caps, Sterile

Part No.	Cap. (mL)	Cap Type	Qty.	Price	SALE Price
CGN-2093-125	125	seal	24	<del>\$133.00</del>	\$106.40 ♣
CGN-2093-250	250	seal	12	<del>\$91.00</del>	\$72.80 ♣
CGN-2093-500	500	seal	12	<del>\$128.00</del>	\$102.40 ♣
CGN-2093-1000	1,000	seal	6	<del>\$98.00</del>	\$78.40 ♣

### Baffled Bottom, PC, Erlenmeyer Flasks with Vent Filter Caps, Sterile

Part No.	Cap. (mL)	Cap Type	Qty.	Price	SALE Price
CGN-2091-125	125	vent filter	24	<del>\$133.00</del>	\$106.40 ♣
CGN-2091-250	250	vent filter	12	<del>\$96.50</del>	\$77.20 ♣
CGN-2091-500	500	vent filter	12	<del>\$135.50</del>	\$108.40 ♣
CGN-2091-1000	1,000	vent filter	6	<del>\$103.50</del>	\$82.80 ♣

## Cap Styles

### Vent Filter Caps



Top



Bottom

### Seal Caps



Top

\* Lab Supply Prod. Line ◇ Life Sciences Consumable Prod. Line



## High Efficiency Erlenmeyer Flasks with Baffled Bottoms, Caps, Polycarbonate, Sterile, NEST

- baffles promote optimal, consistent solution agitation when used with shakers
- USP CLASS VI, polycarbonate has a high standard of transparency
- clear graduation scales for easy observation
- sterilized by E-Beam and non-pyrogenic
- packaged in sterile bags, 4 per case

### Tips

- recommended volume is 30-40% of the bottle volume
- starting speed is 75-125RPM
- set rotation speed according to the application

The imported medical-grade polycarbonate that meets with the requirements of ISO 10993 USP<661> is chosen as the raw materials, which has high transparency, great impact resistance, oxidation resistance and can withstand a high temperature of up to 121°C. The scale is clear and accurate when looked at from the outside, which facilitates the observation of the volume of culture medium. The vent cap is equipped with a 0.22µm breathable filter which is air-permeable and water-proof to efficiently prevent the passing of micro-organisms and contamination and to ensure gas exchange for good growth of cells or bacteria. The products have undergone the tightness test, drop test, high-temperature and high-voltage tests, flatness test, tensile test, endotoxin test, sterilization test, DNA/RNA enzyme-free tests and cell culture test, all the results of which meet the corresponding quality standards.

### Erlenmeyer Flasks, Baffled Bottoms, Sterile

Part No.	Cap. (L)	Cap Type	Qty.	Price	SALE Price
CGN-2166-2LSC	2	seal	4	<del>\$189.50</del>	\$151.60 ♣
CGN-2166-3LSC	3	seal	4	<del>\$298.50</del>	\$238.80 ♣
CGN-2166-5LSC	5	seal	4	<del>\$431.50</del>	\$345.20 ♣
CGN-2166-2L	2	vent filter	4	<del>\$192.50</del>	\$154.00 ♣
CGN-2166-3L	3	vent filter	4	<del>\$302.00</del>	\$241.60 ♣
CGN-2166-5L	5	vent filter	4	<del>\$441.50</del>	\$353.20 ♣

### WIDE MOUTH Erlenmeyer Flasks, PC, Baffled Bottoms, Sterile

Part No.	Cap. (L)	Cap Type	Qty.	Price	SALE Price
CGN-2166-3W	3	vent filter	4	<del>\$302.00</del>	\$241.60 ♣
CGN-2166-3WSC	3	seal	4	<del>\$298.50</del>	\$238.80 ♣



### Cap Styles

#### Vent Filter Caps



Top



Bottom

#### Seal Caps



† Reusable Glass / Plastics Prod. Line ♣ Consumable Prod. Line Ω EDU / Economical Pkg. Prod. Line



CGN-2406-series

### Cell Culture Flasks with Vent Caps, TC, Sterile, NEST

- Made from high clarity, 100% virgin polystyrene
- Sterilized by E-beam
- Vacuum plasma tissue culture treatment
- Clear lot number for batch traceability
- Angled neck for easy access
- Frosted writing and clear graduations
- Notched bottom for slip-free stacking
- Vented caps (with breathable membrane)
- Non-pyrogenic, DNase- and RNase-free

NEST cell culture flasks are available in cell growth areas ranging from 25cm<sup>2</sup> to 225cm<sup>2</sup>. Tissue culture treated with a vent cap. Vent caps with 0.22 µm hydrophobic filters for gas exchange. Packaged in zip bags

### Treated Cell Culture Flasks with Vent Caps, Sterile

Part No.	Flask Size (cm <sup>2</sup> )	Membrane Material	Membrane Pore Size (µm)	Qty.	Price	SALE Price
CGN-2406-125	25	PTFE	0.22	200	<del>\$192.00</del>	\$153.60 ♣
CGN-2406-750	75	PTFE	0.22	100	<del>\$218.00</del>	\$174.40 ♣
CGN-2406-175	175	PTFE	0.22	40	<del>\$160.50</del>	\$128.40 ♣
CGN-2406-225	225	PTFE	0.22	25	<del>\$151.00</del>	\$120.80 ♣

### Cell Culture Plates, Treated, Sterile, NEST

- Made from high clarity, 100% virgin polystyrene
- Sterilized by E-beam
- Vacuum plasma tissue culture treatment
- Clear lot number for batch traceability
- Premium packaging; individually wrapped in peelable HDPE film and blisters
- Non-pyrogenic, DNase- and RNase-free

Nest cell culture plates have round edges for better handling. Low profile, low-evaporation lid design assures uniform growth. Small feet on the bottom corners of each plate eliminate scraping of the microscope lens.

### Sterile, Treated, Cell Culture Plates

Part No.	Wells	Bottom	Bag Qty.	Qty.	Price	SALE Price
CGN-3500-206	6	Flat	1	50	<del>\$104.00</del>	\$83.20 ♣
CGN-3500-212	12	Flat	1	50	<del>\$110.50</del>	\$88.40 ♣
CGN-3500-224	24	Flat	1	50	<del>\$110.00</del>	\$88.00 ♣
CGN-3500-248	48	Flat	1	50	<del>\$112.50</del>	\$90.00 ♣
CGN-3500-096	96	Flat	1	100	<del>\$199.00</del>	\$159.20 ♣
CGN-3500-R96	96	U-Bottom	1	100	<del>\$215.50</del>	\$172.40 ♣
CGN-3500-V96	96	V-Bottom	1	100	<del>\$215.50</del>	\$172.40 ♣
CGN-3500-384	384	Flat	1	100	<del>\$464.00</del>	\$371.20 ♣

\* Lab Supply Prod. Line ♠ Life Sciences Consumable Prod. Line

## Cell Strainers, Sterile, NEST

- Sample filtration and sample preparation for flow cytometer
- Isolate primary cells to consistently obtain a uniform single-cell tissue suspension
- Non-pyrogenic, non-cytotoxic, DNase- and RNase-free

Cell strainer can be used to obtain uniform, single-cell suspension. Compatible with most popular brands of 50mL centrifuge tubes. Frames are made from polypropylene with nylon strainers. Individually packaged.

### Cell Strainers, Sterile

Part No.	Size (µm)	Color	Qty.	Price	SALE Price
CGN-2007-040	40	blue	50	<del>\$118.50</del>	\$94.80 ♣
CGN-2007-070	70	white	50	<del>\$119.50</del>	\$95.60 ♣
CGN-2007-100	100	yellow	50	<del>\$123.00</del>	\$98.40 ♣



CGN-2007-series

See ReadyStrain™ Cell Straining Kits on page 67.

## Cryogenic Vials, Self-Standing, Sterile, NEST

- USP grade VI Polypropylene
- Autoclave at 121°C
- Manufactured in clean room
- Clear graduations and white marking area
- Sterilized by E-Beam, non-pyrogenic, DNase- and RNase-free
- Used for storage in the gas phase of liquid nitrogen
- Optional color inserts available separately for caps (Part No. CGN-4767-series)

Cryogenic vial with special screw cap designed without silicone ring to avoid the contamination risk. Choose internal or external threads.

### Sterile, Self-Standing, Cryogenic Vials with External Threads

Part No.	Cap. (mL)	Bag Qty.	Qty.	Price	SALE Price
CGN-4762-005A	0.5	50	500	<del>\$156.50</del>	\$125.20 ♣
CGN-4762-01A	1.2	50	500	<del>\$165.50</del>	\$132.40 ♣
CGN-4762-02A	2.0	50	500	<del>\$289.00</del>	\$231.20 ♣
CGN-4762-03A	3.0	50	250	<del>\$176.50</del>	\$141.20 ♣
CGN-4762-04A	4.0	50	250	<del>\$139.00</del>	\$111.20 ♣
CGN-4762-05A	5.0	50	250	<del>\$215.50</del>	\$172.40 ♣



CGN-4762-series

### Sterile, Self-Standing, Cryogenic Vials with Internal Threads

Part No.	Cap. (mL)	Bag Qty.	Qty.	Price	SALE Price
CGN-4766-05	0.5	50	500	<del>\$169.50</del>	\$135.60 ♣
CGN-4766-001	1.2	50	500	<del>\$179.00</del>	\$143.20 ♣
CGN-4766-002	2.0	50	500	<del>\$222.00</del>	\$177.60 ♣
CGN-4766-003	3.0	50	250	<del>\$122.50</del>	\$98.00 ♣
CGN-4766-004	4.0	50	250	<del>\$121.00</del>	\$96.80 ♣
CGN-4766-005	5.0	50	250	<del>\$160.50</del>	\$128.40 ♣



CGN-4766-series

† Reusable Glass / Plastics Prod. Line ♣ Consumable Prod. Line Ω EDU / Economical Pkg. Prod. Line



CLS-1370-series

## Electroporation Cuvettes

Bridge electroporation cuvettes efficiently transfer DNA and siRNA into a wide variety of cell types. While the color and shape of the caps may vary from brand to brand, all electroporation cuvettes must meet strict quality assurance specifications to ensure consistent pulse delivery and reproducible results. Bridge cuvettes meet and exceed every measurable qualification and parameter.

### Universal Fit

Manufactured in the USA to tight tolerances for optimum performance, Bridge electroporation cuvettes fit in most manufacturer's systems including those from: Bio-Rad®, BTX®, Invitrogen®, Eppendorf and, Kodak®/ IBI®.

### For a Variety of Applications

It is well documented that nucleic acid delivery via electroporation can achieve remarkable rates of transfer efficiency and maintain good cell viability, even for a variety of finicky human cell lines. In order to achieve the proper electrical field strength to the cells, Bridge electroporation cuvettes are carefully constructed with burr-free, specially processed electrodes and virgin polycarbonate. This results in cuvettes which provide superior results in the most discriminating applications. Available in three gap widths, 1, 2, and 4 mm, it's as simple as choosing the correct cuvette size for your application.

## Electroporation Cuvettes

Part No.	Description	Qty.	Price
<b>CLS-1370-01</b>	Electroporation Cuvettes, 1mm	50	<b>\$157.90</b> *
<b>CLS-1370-02</b>	Electroporation Cuvettes, 2mm	50	<b>\$157.90</b> *
<b>CLS-1370-03</b>	Electroporation Cuvettes, 4mm	50	<b>\$157.90</b> *

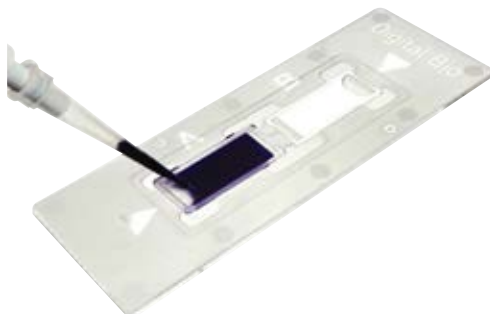

CLS-4207-01

## C-Chip Disposable Hemocytometers

- Use with general, mammal, erythrocyte and leukocyte cell counting
- Dimensions: 25 x 75 x 1.6mm
- Chamber depth: 100um
- Chambers per chip: 2
- Tests per box: 100
- Grid: Neubauer improved

Disposable plastic hemocytometer that improves upon the conventional glass variety. The C-Chip™ offers the ability to eliminate tedious washing and reduce exposure to infectious samples and contamination. In a conventional glass hemocytometer, improper fitting of the chamber and cover slip changes the volume of the sample introduced into the chamber. The C-Chip™ all-in-one "chamber with an integrated cover" solves the problem. The C-Chip™ contains two precision engineered 100 µm height counting chambers that do not need cover slips. Just pipette 10µl of sample into each chamber, place on the microscope and you are ready to count. Then dispose once finished. It's that simple.

Packaged 50 slides (2 tests per slide) per box, individually sealed with a lot certificate in every box.

## C-Chip Disposable Hemocytometers

Part No.	Qty.	Price
<b>CLS-4207-01</b>	50	<b>\$157.00</b> *

\* Lab Supply Prod. Line ◇ Life Sciences Consumable Prod. Line

## Glass Bottom Cell Culture Dishes and Plates

Dishes and plates used in confocal, differential interference contrast, polarized light and phase contrast microscope for cell observation.

**Culture dishes** are ideal for live cell observation. Complete with medical grade adhesive to guarantee non-cytotoxicity. They are also ideal for live cell microscopy and live cell imaging. Optical grade glass thickness is 0.16-0.19mm.

### Glass Bottom Cell Culture Dishes - Sterilized by E-beam Sterilization

Part No.	Dims. (mm)	Glass Bottom Dia. (mm)	Qty.	Reg. Price	SALE Price
CLS-1811-001	35 x 10	15	10	<del>\$27.50</del>	\$22.00 ♣
CLS-1811-002	35 x 10	20	10	<del>\$32.00</del>	\$25.60 ♣



CLS-1811

*Non-cytotoxic,  
non-pyrogenic  
and sterile.*

**Culture plates** for high-resolution microscopic images of cultures growing in standard size 6- and 24-well disposable plastic cell culture plates. Made using high volume, automation to ensure lot-to-lot reproducibility and cost effective pricing. The first step is to precisely cut an opening in the center of the culture well plates. A clinically non-toxic adhesive is used to attach a high quality technical grade glass cover slip of standard thickness (0.13-0.16mm) to the bottom of each well. Cover slips are borosilicate glass of the highest hydrolytic consistency and are well adapted for a broad variety of applications.

### Glass Bottom Cell Culture Plates - Sterile

Part No.	No. of Wells	Well Dia. (mm)	Qty.	Reg. Price	SALE Price
CLS-1812-006	6	24	1	<del>\$41.00</del>	\$32.80 ♣
CLS-1812-024	24	10	1	<del>\$49.00</del>	\$39.20 ♣



CLS-1812

## Cell Culture Plates, Non-Treated, Sterile, NEST

- Made from high clarity, 100% virgin polystyrene and sterilized by E-beam
- Premium packaging; individually wrapped in peel-able HDPE films and blisters
- Non-Pyrogenic, DNase- and RNase-free

Nest cell culture plates have round edges for better handling. Low profile, low-evaporation lid design assures uniform growth. Small feet on the bottom corners of each plate eliminate scraping of the microscope lens. Nontreated growth surface is more hydrophobic than tissue culture surface and is similar to the surface of a bacteriological Petri dish. Come with clear lot numbers for batch traceability.

### Sterile Cell Culture Multi-Well Plates, Non-Treated

Part No.	No. of Wells	Bottom	Pkg. Qty.	Qty.	Price	SALE Price
CGN-3501-206	6	flat	1	50	<del>\$101.00</del>	\$101.00 ♣
CGN-3501-212	12	flat	1	50	<del>\$107.00</del>	\$107.00 ♣
CGN-3501-224	24	flat	1	50	<del>\$107.50</del>	\$107.50 ♣
CGN-3501-248	48	flat	1	50	<del>\$107.50</del>	\$107.50 ♣
CGN-3501-096	96	flat	1	100	<del>\$189.50</del>	\$189.50 ♣
CGN-3501-R96	96	U-bottom	1	100	<del>\$212.00</del>	\$212.00 ♣
CGN-3501-V96	96	V-bottom	1	100	<del>\$212.00</del>	\$212.00 ♣
CGN-3501-384	384	flat	1	100	<del>\$422.00</del>	\$422.00 ♣

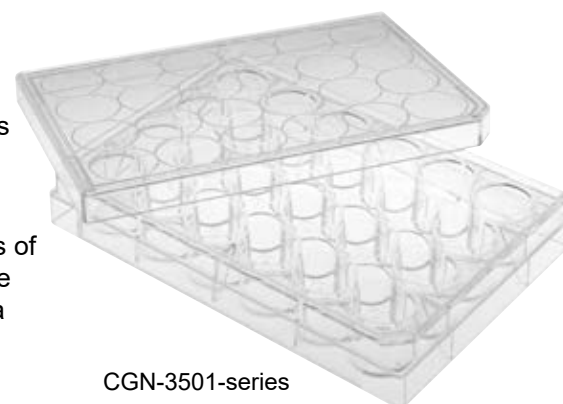

CGN-3501-series



Premium packaging;  
individually wrapped in peel-able HDPE films and blisters

† Reusable Glass / Plastics Prod. Line ♣ Consumable Prod. Line Ω EDU / Economical Pkg. Prod. Line



CGN-4285-050

### Tubes, Bio-Reaction, Centrifuge, 50mL, Sterile, NEST

- USP Class VI polypropylene tubes with HDPE caps
  - Packaged in sterile, zip-sealable bags
  - Non-pyrogenic, non-cytotoxic, DNase- and RNase-free, human DNA-free
- Bio-reaction tubes offer a convenient and economical option for suspension cell culture. Bio-reaction tubes include vent caps for gas exchange; 0.22µm hydrophobic membranes are welded in. These tubes provide an environment perfect for small scale suspension culture or biological reaction experiments that require aseptic conditions with free gas exchange. Bio-reaction tubes are extremely useful in the screening and optimization processes of suspension cells. Reaction parameters can be optimized with small amounts of material which can maximize the number of parallel experiments that can be done.

#### Sterile Bio-Reaction Centrifuge Tubes

Part No.	Cap. (mL)	Qty.	Price	SALE Price
CGN-4285-050	50	100	<del>\$145.50</del>	\$116.40 ♣

Graduations,  
marking spots  
and vented caps

*Tubes feature easy-to-read, black graduations, large marking areas and vented caps.*

### Cell Scrapers, Individually Wrapped, Sterile, NEST

- Improved designs to the blade and handle provide maximum accessibility in a variety of culture vessels
- Two sizes available
- Easy-tear sterile packing
- Sterilized by E-Beam, non-pyrogenic, DNase and RNase-free

Cell scrapers are for tissue culture harvesting from flasks, plates, or dishes. Designed to gently remove cells, scrapers maximize sample recovery. Improved blade and handle design provides maximum accessibility to the growth surface in a variety of culture vessels.

#### Sterile, Individually Wrapped, Cell Scrapers

Part No.	Handle Length (mm)	Blade Length (mm)	Qty.	Price	SALE Price
CGN-2403-013	220	13	100	<del>\$80.00</del>	\$64.00 ♣
CGN-2403-030	280	20	100	<del>\$87.00</del>	\$69.60 ♣



CGN-2403-series

\* Lab Supply Prod. Line ♠ Life Sciences Consumable Prod. Line



### Drosophila Bottles / Flasks, Non-Sterile

- Made from polypropylene
- Molded graduations up to 100mL in 25mL increments
- Autoclavable Drosophila bottles
- Transparent bottle with square bottom
- Compatible with CGE-4790 plugs listed below

**Plugs sold separately.**

### Non-Sterile, Polypropylene, Drosophila Vials with Square Bottoms

Part No.	Size (mL)	Accommodate Plugs	Qty.	Price
<b>CGE-4789-005</b>	177 (6oz)	<b>CGE-4790-005</b>	25	<b>\$24.40</b> Ω



CGE-4789-005

### Drosophila Vials, Narrow and Wide

- Made from premium grade, transparent polystyrene
- Narrow, wide drosophila vials are glass-like clarity for sample observation
- Disposable vials are a safe and cost-effective alternative to glass vials
- Narrow vials 25x95mm or wide vials 28.5x95mm available
- Compatible with CGE-4790 plugs listed below

**Plugs sold separately.**

### Non-Sterile, Clear Polystyrene, Drosophila Vials

Part No.	Size (mm)	Accommodate Plugs	Qty.	Price
<b>CGE-4789-001</b>	25 x 95 (narrow)	<b>CGE-4790-001</b>	25	<b>\$18.15</b> Ω
<b>CGE-4789-003</b>	28.5 x 95 (wide)	<b>CGE-4790-003</b>	25	<b>\$18.35</b> Ω



CGE-4789-series

### Drosophila Plugs, High Density Foam

- Made of high-density foam
- Cause minimal shedding and reduce evaporation
- Maintain tight fit after repeated use and removal
- Compatible with CGE-4789 Drosophila vials and bottles

*Order containers and plugs separately.*

### Non-Sterile, High Density Foam, Drosophila Plugs

Part No.	Fit	Qty.	Price
<b>CGE-4790-001</b>	Narrow Drosophila Vials	100	<b>\$27.25</b> Ω
<b>CGE-4790-003</b>	Wide Drosophila Vials	100	<b>\$25.95</b> Ω
<b>CGE-4790-005</b>	Drosophila Bottles	100	<b>\$36.10</b> Ω



CGE-4790-series



CLS-1905-01

### Mini-Run Gel Electrophoresis System

Mini-Run horizontal gel apparatus can be used for almost any agarose gel electrophoresis application. Built-in DC power supply; plug it in and be ready to run. Cover and gel chamber are both made from an advanced, etch-resistant plastic and electrodes are platinum-coated for clean operation and durability.

#### Mini-Run Gel Electrophoresis System

Part No.	Qty.	Price
CLS-1905-01	1	\$485.30 *

### Electrophoresis Gel Band Cutters, Disposable, FASTGENE

Disposable gel band cutters provide an easy, affordable way to excise DNA bands with both consistency and accuracy. They simplify fragment purification and eliminate wasted effort associated with knives and razor blades. The size of excised gel bands will always be 6 mm x 3 mm, and multiple bands can be collected in a single cutter; large scale purifications become that much easier. Band weight depends on agarose percentage and thickness; please see the table below.

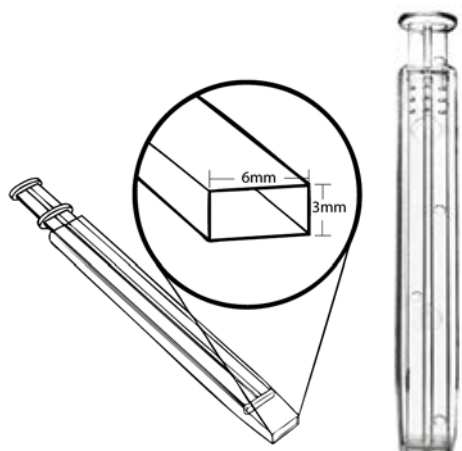

CLS-1909-C100

#### Agarose Gel Band Cutter, Disposable

Part No.	Qty.	Price
CLS-1909-C100	50	\$91.40 *

#### Excised Gel Band Weights Table

Gel Thickness (cm)	2% Agarose Gel Weight (mg)	1% Agarose Gel Weight (mg)
1.0	~140	~130
0.8	~120	~110
0.6	~100	~90



CLS-1909-G01

### Midori Green Nucleic Acid Staining Solution

- Non-toxic, non-mutagenic, and non-carcinogenic
- Excitation: 270 nm and 290 nm (fluorescence) 490nm (visible)
- Emission: 530 nm (fluorescence)
- Compatible with UV transilluminator and blue LED transilluminator
- Can be stored at room temperature, protected from light

Midori green nucleic acid staining solution is a new and safe alternative to the traditional ethidium bromide (EtBr) stain for detecting dsDNA, ssDNA and RNA in agarose gels. **Midori green is just as sensitive as EtBr** and the staining protocol is also very similar. Midori green binds less aggressively to the DNA molecules, so fewer mutations occur during synthesis. Compared to EtBr, which is known as a strong mutagen, midori green causes much fewer mutations in the Ames test. Most importantly, it is not considered hazardous waste, can be disposed of according to standard laboratories procedures, and is stable for years.

#### Midori Green Nucleic Acid Staining Solution

Part No.	Size (mL)	Qty.	Price
CLS-1909-G01	1 (20,000x)	1	\$152.40 *

\* Lab Supply Prod. Line ◇ Life Sciences Consumable Prod. Line



## Agarose LE, Organic, Solvent-Free

- Multi-purpose, high purity
- Enhanced resolution and clarity
- Reduced background
- Low EEO / increased electrophoretic mobility
- RNase-, DNase- and protease-free
- High hysteresis / improved thermal stability

Agarose LE is a highly purified agarose, used for nucleic acid electrophoresis (analytical and preparative), protein electrophoresis (including radial immunodiffusion) and various blotting protocols. It's refined using a process that excludes organic solvents, yielding a cleaner end-product with a significantly reduced environmental impact. Agarose LE can be used for analyses of proteins and nucleic acids of various sizes (150bp to 6kbp).

Its low EEO (Less than or equal to 0.13mr) promotes increased electrophoretic mobility, yielding improved resolution and shorter run times. This also allows macromolecules and larger particles (subcellular fragments, viruses, etc.) to migrate more freely through the gel matrix. The consistently low EEO also provides a reduction in band distortion (caused by counter flow) that can result from the presence of excessive sulfate-rich negative ions.

Benchmark Agarose LE is easily soluble and free of nucleases. It is highly transparent (forms a clear, colorless solution at 1g: 100mL H<sub>2</sub>O), and exhibits exceptionally low absorption of chemical staining agents. Pore size can be adjusted by simple modifications to the concentration ratio.

Formulated for high gel strength and integrity, Agarose LE exhibits exceptional thermal stability and mechanical resistance, ensuring safe, easy handling, regardless of whether a denaturing agent has been added.

### Agarose LE

Part No.	Size (g)	Qty.	Price
CLS-1910-025	25	1	\$58.00 ◇
CLS-1910-100	100	1	\$139.85 ◇
CLS-1910-500	500	1	\$487.40 ◇



CLS-1910-500



CLS-1910-100

**Special OFFER on Agarose LE**

**FREE 100g**

\* Participation restricted to purchases at list price of Agarose LE 500g, CLS-1910-500, only. Offer valid from 1/1/2024 through 12/31/2024. Purchaser must specify promo code **BM24-1910** when placing the order.

**Valid on US and Canadian purchases only.** May not be combined with any other offer or discount. This offer is non-transferable and void where prohibited by law or company policy. Subject to Chemglass Life Sciences' standard terms, conditions and contracts. **Not valid through distributors.**

**Buy a 500g bottle.  
Get a FREE 100g bottle\***

8L



CLS-1191-008

18L



CLS-1191-018

28L



CLS-1191-B-028

## BioClave™ Benchtop Autoclaves in Three Sizes

- Fully automatic
- Built-in water tank - no external water required

Despite their space-saving exterior dimensions, BioClave stainless steel sterilization chambers are surprisingly large. They can accommodate a variety of liquids, media, instruments, glassware, plasticware and other common laboratory items.

BioClaves include mechanical and electrical safety interlocks that prevent doors from being opened until the pressure has reached zero PSI.

With large digital displays and fully automatic operation, all segments of the sterilization cycle (fill, sterilize, exhaust and dry) commence and run to completion by simply pressing the start button. All BioClaves offer three cycle options (standard programs), which are preset for the sterilization of liquids, wrapped instruments or unwrapped instruments / plasticware. A “Dry Only” option is also available for additional drying time to be added to the end of a cycle. For special applications, requiring variations in cycle parameters, the cycle times are fully adjustable. A built-in USB port allows for transfer / storage of cycle data.

An optional thermal mini-printer is also available for providing a record of sterilization parameters.

The **NEW BioClave 28** features an increased chamber size with a diameter of 12.6 inches (32cm), making it capable of sterilizing 1 and 2 liter flasks and bottles.

Benchtop Autoclaves are CE approved.

### BioClave™ Mini Benchtop Autoclave

Part No.	BioClave Cap. (L)	Outer Dims. W x D x H (in.)	Chamber Dia. (in.)	Qty.	Price
CLS-1191-008	8	14 x 13.5 x 12.9	6.7	1	\$5,040.60 *
CLS-1191-018	18	22 x 17.5 x 15.7	9.8	1	\$6,973.80 *
CLS-1191-B-028	28	25 x 25 x 22	12.6	1	\$12,842.85 *

### Accessory Printer and Paper

Part No.	Description	Qty.	Price
CLS-1191-001	Printer for 18 and 28L BioClaves	1	\$352.45 *
CLS-1191-003	Paper for CLS-1191-001	1	\$47.70 *

## FREE Block with Multi-Therm Purchases\*



CLS-6001-100

### Multi-Therm Temperature Controlled Vortexing Shakers

\* Participation in this offer is limited to purchases made from 1/1/2024 through 12/31/2024 of Multi-Therm Shakers, CLS-4031-001 or CLS-4030-001 or -003 from Chemglass Life Sciences. Receive a free Multi-Therm Block, CLS-4031-011 or CLS-4030-011, with purchase. To qualify, purchaser must specify promo code **BM24-4031** with order.

**Valid on US and Canadian purchases only.** May not be combined with any other offer or discount. This offer is non-transferable and void where prohibited by law or company policy. Offer is subject to Chemglass Life Sciences' standard terms, conditions and contracts. **Offer not valid through distributors.**

\* Lab Supply Prod. Line ◇ Life Sciences Consumable Prod. Line

## Autoclave Bags - Maximum Protection & Performance

Durable 0.002-inch thick transparent polypropylene bags can be filled with used labware for autoclaving and disposal. Two, large-size bags hold 65 and 200mm, Petri dishes respectively. Steam autoclavable at 135°C (275°F).

### Autoclave Bags, Transparent Polypropylene

Part No.	Bag Size (in)	Qty.	Price
CLS-1192-1224	12 x 24	100	\$50.00 ◇
CLS-1192-2430	24 x 30	100	\$166.30 ◇

CLS-1192-series  
Autoclave Bags



## Autoclave Bag Clips for Closing Filled Bags

Clips permit bags to safely vent internal pressure during autoclaving. Open and close the clips with one hand. After autoclaving, clips hold the processed bags closed for final disposal. The closed internal dimension of the clip is 7/16".

### Autoclave Bag Clips

Part No.	Fit Bags (in.)	Qty.	Price
CLS-1192-C001	12 x 24 to 24 x 36	100	\$25.25 ◇



CLS-1192-C001

## BowTie Biohazard Autoclave Bags with Drawstrings

- Large, marking area with color-changing, sterilization indicator

BowTie™ biohazard bags exclusive drawstring loops provide an instant cinch closure and easy removal from bag stands. They allow for venting during sterilization and offer an easy, safe way to remove bags from a hot autoclave. Bags are clearly marked with a biohazard symbol. Made of 2.25 mil HDPE and suitable for autoclaving in 121°C cycles.

### BowTie Biohazard Autoclave Bags with Drawstrings

Part. No.	Dims. (cm)	Cap. (L)	Qty.	Price
CLS-1192-2436	64 x 89 (25 x 35 in.)	45-60 (12-16 gal.)	100	\$159.45 ◇



CLS-1192-2436

## Lead-Free, Color-Changing, Autoclave Indicator Tape

*Environmentally friendly* autoclave tape

- FDA process indicator
- Designed for gravity sterilizers at 121°C for 30 minutes and pre-vacuum steam sterilizers at 132°C for 3 minutes and 135°C for 3 minutes.

Color changes from green to black after going through the steam sterilization process. Tape can be adhered directly to items.

### Autoclave Indicator Tape

Part No.	Description	Width (in.)	Length (in.)	Qty.	Price
CLS-1194-075	Lead-Free	3/4"	2160"	1	\$11.50
CLS-1194-100	Lead-Free	1"	2160"	1	\$21.40



CLS-1194-series



Used tape turns from green to black.



CLS-3956-01

### MyBlock™ Mini Digital Dry Bath

MyBlock Mini fits almost anywhere and can be used “on-the-go” in cars, boats or wherever a 12-volt power source is available. The pad control with digital display is designed for “set and walk away” operation. The MyBlock Mini is less than five inches wide. Blocks are not included with the dry bath and must be purchased separately.

#### MyBlock™ Mini Digital Dry Bath

Part No.	Voltage	Qty.	Price
CLS-3956-01	120	1	\$315.30 *

#### Blocks and Accessory Power Adapter

Part No.	Description	Qty.	Price
CLS-3956-02	Block, 40 x 0.2mL Centrifuge Tubes or 5 x PCR Strips	1	\$112.60 *
CLS-3956-05	Block, 24 x 0.5mL Centrifuge Tubes	1	\$112.60 *
CLS-3956-15	Block, 15 x 1.5mL Centrifuge Tubes	1	\$112.60 *
CLS-3956-17	Block, 15 x 1.5 or 2.0mL Centrifuge Tubes	1	\$112.60 *
CLS-3956-19	Block, 4 x 15mL Centrifuge Tubes	1	\$142.75 *
CLS-3956-21	Block, 2 x 50mL Centrifuge Tubes	1	\$142.75 *
CLS-3956-30	Vehicle Power Adapter, 12V	1	\$60.45 *

\*Life Science Equipment Product Line



CLS-1610-100



### Compact High Speed Microcentrifuge, 16,000 xG

The MC-12 is the first and only compact microcentrifuge capable of achieving centrifugal speeds up to the critical threshold of 16,000 xG, often held as the standard for many molecular biology / DNA protocols. Its brushless, maintenance free drive system makes it powerful, yet compact enough to allow each work station to be fully equipped with a personal centrifuge.

MC-12 defines a new class of microcentrifuge: compact, quick, powerful and affordable. All aspects of microcentrifuge performance were taken into consideration and no compromises were made. In addition to its unsurpassed speed, the MC-12 also delivers shortened acceleration / deceleration times, whisper quiet operation. Its computer-designed airflow pattern minimizes sample temperature increases during longer runs at high speeds.

All operating parameters are set using a single, conveniently located control knob and the large, bright LCD provides a clear indication of time and rpm or g-force. A separate momentary spin button permits instant spin downs, without setting or disturbing any preset parameters. The aircraft grade aluminum rotor accepts 1.5 to 2.0mL tubes directly, as well as 0.5 and 0.2mL tubes with optional adapters. Cold room safe for applications requiring sub-ambient temperatures.

#### Compact High Speed Microcentrifuge

Part No.	Description	Qty.	Price
CLS-1610-100	With 12 x 1.5 / 2.0mL Rotor, 115V	1	\$1,690.35 *

\* Lab Supply Prod. Line ♦ Life Sciences Consumable Prod. Line

## MC-24 Touch, High Speed, Microcentrifuge

- Full Color Touch Screen and mySpin™ 1-button program recall
- Includes 24-place Combi-Rotor™ for tubes and strips
- Compact design, 9 x 12 x 7.75 inches
- Unique air-flow, keeps samples cool

In addition to the next generation, touch screen, control panel, the MC-24 offers high speeds (up to 13,500 rpm / 16,800 xG) and a unique COMBI-Rotor™ that accepts both standard microtubes (1.5 / 2.0mL) and PCR tubes / strips (0.2mL).

Large, touch screen shows actual speed (in rpm or rcf) along with set and remaining time. Up to nine speed / time profiles can be stored in memory and the home screen displays a “mySpin” icon for instant recalls of favorite profiles.

Supplied with Benchmark’s unique COMBI-Rotor™, the MC-24 Touch will accept 24 x 1.5 / 2.0mL tubes and two strips of 0.2mL tubes (16 x 0.2mL) without requiring separate adapters. Samples are kept cool, even during extended runs at the maximum speed setting by a proprietary air flow system that moves air evenly and quietly throughout the chamber.

The MC-24 Touch is cold room safe and carries a two-year warranty.

### MC-24 Touch High Speed Microcentrifuge

Part No.	Description	Qty.	Price
CLS-1613-100	With 24-Place Combi-Rotor, 115V	1	\$2,666.55 *

*Perfect for  
molecular  
bio labs*



CLS-1613-100

- 12 tube capacity / up to 16,000 xG
- Whisper quiet operation
- Less than nine inches wide
- Quick deceleration



### FREE OFFER Mini Centrifuge



CLS-1606-01

Participation in this offer is limited to purchases made in the period from 1/1/2024 through 12/31/2024 of a Benchmark MC-24 Touch, High-Speed Microcentrifuge, CLS-1613-100, from Chemglass Life Sciences. Receive a Free MyFuge Mini Centrifuge, CLS-1606-01 with purchase. To qualify, purchaser must specify promo code **BM24-1606** when placing the order.

Valid on US and Canadian purchases only. May not be combined with any other offer or discount. Non-transferable and void where prohibited by law or company policy. Subject to Chemglass Life Sciences' standard terms, conditions and contracts. Not valid through distributors.

† Reusable Glass / Plastics Prod. Line ♣ Consumable Prod. Line Ω EDU / Economical Pkg. Prod. Line



CLS-1615-series



Intuitive Control Panel

### Microprocessor Control

- Over-speed protection
- Program storage
- Pre-cool function on refrigerated model
- Momentary spin button
- Imbalance detection
- Adjustable acceleration and deceleration
- Audible end-of-run alarm

## HERMLE Compact Microcentrifuges

- Speed up to 15,000rpm
- G-Force up to 21,379 x G
- Maintenance-free induction drive
- Motor driven safety lid lock
- Quiet operation: less than 60 decibels
- Splash-proof display

Refrigerated model  
also available!

Compact, quiet and powerful are just a few words that describe these HERMLE microcentrifuges. Plus, the versatility of eight available rotor options and the result is the ideal microcentrifuge for the modern molecular biology laboratory.

All common microtubes (0.2, 0.5, 1.5, & 2.0mL) can be used as well as PCR strips, hematocrit tubes and even 5.0mL centrifuge tubes. Advanced microprocessor controls allow for setting / displaying of the rotational speed in either rpm or rcf. In addition to retrieving saved programs, the easy to use front panel can adjust acceleration / deceleration rates, and change the end of run alarm tone.

Despite a remarkably small footprint, they offer a uniquely designed 44 x 1.5mL dual row rotor, nearly doubling the capacity when compared to traditional microcentrifuges.

The refrigerated model offers a powerful, compressor-driven cooling system that maintains temperatures as low as -20°C and is designed to reach 4°C (from room temperature) in less than ten minutes.

### HERMLE Compact Microcentrifuges - Purchase Rotors Separately

Part No.	Description	Qty.	Price
CLS-1615-100	Without Rotor, 120V	1	\$3,326.95 *
CLS-1615-102	Refrigerated, Without Rotor, 120V	1	\$6,792.85 *

### Rotors for HERMLE, CLS-1615-series, Microcentrifuges Only

Part No.	Description	Qty.	Price
CLS-1615-200	24 x 1.5 / 2.0mL Angle Rotor (45°)	1	\$933.60 *
CLS-1615-202	44 x 1.5 / 2.0mL Angle Rotor (32°/55°)	1	\$1,032.20 *
CLS-1615-203	24 x 1.5/2.0mL & 4 x PCR Strips, Combi Rotor (32°/55°), Quick Lock Lid	1	\$1,714.00 *
CLS-1615-204	24 x 1.5 / 2.0mL Angle Rotor (45°), Hermetically Sealed Lid	1	\$1,437.20 *
CLS-1615-206	30 x 1.5 / 2.0mL Angle Rotor (45°), Hermetically Sealed Lid	1	\$1,216.05 *
CLS-1615-208	64 x 0.5mL Angle Rotor (40°/55°)	1	\$1,444.35 *
CLS-1615-210	4 x 8 PCR Strips / 32 x 0.2mL (45°), Hermetically Sealed	1	\$1,241.25 *
CLS-1615-212	12 x 5.0mL (45°), Hermetically Sealed	1	\$1,169.15 *
CLS-1615-214	24 x Capillaries (90°), Rotor	1	\$908.45 *

\* Lab Supply Prod. Line ◇ Life Sciences Consumable Prod. Line

## Mini Centrifuges

- Quiet, vibration-free operation
- Include two, easy-to-change rotors

These mini centrifuges are popular for quick spins, microfiltration of samples, and cell separations. The covers are made of high strength plastic and provide easy viewing of samples. These centrifuges quickly accelerate to their maximum speed and stop within seconds. Manufactured to precise specifications, resulting in smooth runs that are quiet and vibration-free. Included is a round rotor with capacity for six standard microtubes (1.5 to 2.0mL) as well as a strip tube rotor for 2 x 8 PCR strips or sixteen individual 0.2mL tubes. The rotors can be easily interchanged by the user within a matter of seconds. Other RPMs are available, please contact us for details.

	RPM	4000	8000
	RCF	900 xG	3600 xG
Microtube Rotor / Capacity		6 x 1.5mL / 6 x 0.5mL 16 x 0.2mL	6 x 1.5 / 2mL
PCR Strip Rotor Capacity		2 x 8 strips or 16 x 0.2mL tubes	2 x 8 strips or 16 x 0.2mL tubes
Dimensions, WxDxH (in.)		5.5 x 6.1 x 4.5	5.5 x 6.1 x 4.5
Operating Temp.		+5 to ~40 °C	+4 to 50 °C
Electrical		AC110~240V, 50/60Hz	110V, 50/60Hz, 0.1A
Warranty		1 Year	1 Year

Part No.	Speed (rpm)	Color	Qty.	Price
CLS-1601-012	4,000	purple with clear lid	1	\$272.60 *
CLS-1601-008	8,000	white with green lid	1	\$252.40 *

*Other RPMs available, please contact us for details.*

CLS-1601-012  
4000 rpm



CLS-1601-008  
8000 rpm



## Special OFFER 8000rpm Mini Centrifuges

Two for \$250

\* Restricted to purchases at list price of **CLS-1601-008 Mini Centrifuges only**. Receive two CLS-1601-008 for \$250. Offer valid from 1/1/2024 through 12/31/2024. Purchaser must specify promo code **CENT24** when ordering.

**Valid on US and Canadian purchases only.** May not be combined with any other offer or discount. Valid while supply lasts. Non-transferable and void where prohibited by law or company policy. Subject to Chemglass Life Sciences' standard terms, conditions and contracts. **Not valid through distributors.**



CLS-1601-008



## BeadBath Duo™

Designed for precision temperature control with either water or Lab Armor® beads.

### All the advantages of a “Bead Bath”

- eliminates constant refills (burn-out protection)
- easy, accessory-free securing of tubes & bottles
- allows angled incubations
- designed to be left on constantly

## BeadBath Duo - Accurate, Uniform Temperature Control with Separate Modes for Beads or Water

Unlike any other laboratory bath, they feature a “MODE” button that can be used to toggle between “Bead” or “Water” mode. Choosing the correct mode will regulate the internal heating system, automatically adjusting the operation and balance of the multiple internal heating elements to ensure optimal performance. The result is one combination bath that is suitable for accurate and uniform temperature control in either condition.

While the majority of research laboratories today are using water baths, many prefer the convenience of bead baths. The BeadBath Duo™ provides the best of both worlds, allowing conversion from one bath type to the other, with the simple press of a button. Quick-Cal™, simple in-lab calibration function.

### BeadBath Duo

Part No.	Cap. (L)	Lids	Price
CLS-4599-001	2	Lift-Off Lid	\$835.45 *
CLS-4599-002	10	Hinged Lid	\$1,424.70 *

Lab Armor™  
Beads extend the  
life of your bath  
by eliminating  
corrosion and  
reducing burn-out  
risk.

## Lab Armor Beads Replace Water and Ice in Baths, Blocks and Buckets

Dry metallic beads replace water and ice in baths, blocks, and buckets while maintaining temperatures of -20°C to 8°C for 4 or more hours. Open sources of water can put labs at risk of incubating and spreading biological or chemical contamination between samples, equipment and people. Unknown contamination in water can readily enter your incubating samples, resulting in distorted data and non-reproducible results. Lab Armor™ bead technology can save you countless hours of reworking ruined experiments and eliminate cleaning.

For best performance, use product at an operating temperature of -80 to 180°C. However, product may be used up to 300°C without loss in thermal performance, but product fluidity may be reduced. Please contact technical services for specific recommendations.



Part No.	Qty. (L)	Containers	Price
CLS-2991-075	0.75	1	\$112.70 *
CLS-2991-002	2	1	\$316.70 *
CLS-2991-004	4	1	\$584.60 *
CLS-2991-008	8	2 x 4L	\$827.40 *

Part No.	Qty. (L)	Containers	Price
CLS-2991-012	12	3 x 4L	\$1,339.10 *
CLS-2991-016	16	4 x 4L	\$1,785.60 *
CLS-2991-020	20	5 x 4L	\$2,174.80 *

Lab Armor® is a registered trademark of Lab Armor, LLC.

\* Lab Supply Prod. Line ◇ Life Sciences Consumable Prod. Line



**Discover  
Advanced  
Vortexing**



CLS-4889-01

**No Press! No Stress!**  
Reduce Repetitive Strain



CLS-4889-V01

### Vortex Mixer with Infrared Sensor

Advanced infrared sensor vortex mixer with an adjustable mixing speed and two operation modes: sensor or continuous. The revolutionary IR sensor mode, an infrared system, detects the presence of the test tube and the vortex mixer automatically starts vibrating! No press, no stress and no pressure required to maintain vibration. The technopolymer structure ensures chemical resistance. The ergonomic and highly innovative design along with the zinc base ensure excellent stability on the bench.

### Velp Vortex Mixer with Infrared Sensor

Part No.	Qty.	Price
CLS-4889-01	1	\$468.00 *

### Low Profile Vortex Mixer with Infrared Sensor

Vortex mixer features a highly innovative and attractive design. Compact low profile mixer incorporates an infrared sensor with an adjustable mixing speed and two operation modes: sensor or continuous. The revolutionary IR sensor mode uses an infrared system (IR) to detect the presence of the tube and automatically starts vibrating! No press, No stress! No pressure is required to maintain vibration. The technopolymer housing and zinc base ensures optimum chemical resistance and excellent stability on the bench.

### Velp Low Profile Vortex Mixer with Infrared Sensor

Part No.	Qty.	Price
CLS-4889-V01	1	\$410.00 *

## Accessory Platforms and Cups for VELP Vortex Mixers with Infrared Sensors

94mm Customizable  
Foam Platform  
CLS-4889-07

Microtube Foam  
Platform  
CLS-4889-09



Rubber Cup  
CLS-4889-11

50mm Rubber Platform  
CLS-4889-03

Part No.		Qty.	Price
CLS-4889-03	50mm Rubber Platform	1	\$38.50 *
CLS-4889-05	94mm Foam Platform	1	\$42.00 *
CLS-4889-07	94mm Customizable Foam Platform	1	\$50.50 *
CLS-4889-09	Foam Microtube Platform, 1.5mL Microtubes, 19-Position	1	\$62.00 *
CLS-4889-11	Pop-Off Rubber Cup	1	\$24.20 *

\*Life Science Equipment Product Line

Accept up to  
5 liter flasks



CG-2000-V10

### Digital Magnetic Stirrer with Timer, Low Profile, VELP

#### Reliable and Precise

- On board timer for unattended operation
- Auto reverse of the stirring direction to ensure better mixing
- SpeedServo™ technology maintains stirring speed during viscosity changes

#### Robust Structure and Compact Design

- Equipped with a brushless motor
- Technopolymer case guarantees high resistance to chemicals
- White surface for easy visualization of particles and color changes

The MST is a compact, low profile, digital stirrer with a **manually adjustable speed range of 80-1500 RPM**. The bright, digital display allows for very accurate setting of the stirring speed which is adjustable in 10 rpm increments. SpeedServo™ technology provides for constant stirring speeds even during viscosity changes.

#### Digital Magnetic Stirrer with Timer

Part No.	Speed Range (rpm)	Volts	Hz	Qty.	Price
CG-2000-V10	80-100	100-240	50-60	1	\$251.00 *

Accept up to  
5 liter flasks



CG-2002-V10

### Analog Magnetic Stirrer, Low Profile, VELP

Powerful, compact, low profile, single position, analog stirrer has a **manually adjustable speed range up to 1100 rpm**. Long life operation.

#### Robust Design

- Technopolymer casing resists chemicals
- White surface for visualization of particles and color changes

#### Reliable Results

- Accepts up to 5 liter flasks
- Remains cold, even after days of continuous use
- Excellent speed control, even at low speeds

#### Analog Magnetic Stirrer

Part No.	Max. Speed (rpm)	Volts	Hz	Qty.	Price
CG-2002-V10	1100	100-240	50-60	1	\$129.00 *

## VELP Digital, Large Capacity, Magnetic Stirrers



See these part numbers on the web at  
[www.cglifesciences.com](http://www.cglifesciences.com)

CLS-4108	8 liter
CLS-4109	25
CLS-4110	50

\* Lab Supply Prod. Line ♦ Life Sciences Consumable Prod. Line

### Bottle Top, Vacuum Filter Systems with Molded Graduations

- High flow rates and throughput
- Low protein binding low chemical extractable
- Non-pyrogenic and surfactant-free
- 0.22µm membrane PES
- Molded clear graduation on both filter tops and receiving bottles
- 45 mm bottle tops fit most 45 mm neck plastic and glass media storage bottles
- Easy grip style receiving bottles can also be used as storage bottles
- Maximum bottle volume is greater than filter tops, eliminating overflow

Disposable filter systems are useful for large volume sample separation and sterilization for tissue culture media and other biological buffers. PES membrane filters with graduated filter tops made with polystyrene, and polyethylene necks with polystyrene receiving bottles. A separate sterile polyethylene cap is included.

### Bottle Top, Vacuum Filter Systems with Molded Graduations

Part No.	Description	Qty.	Price	SALE Price
CGN-2009-005	250mL System, PES, 0.22µm	12	<del>\$130.50</del>	\$104.40 ♣
CGN-2009-007	500mL System, PES, 0.22µm	12	<del>\$175.00</del>	\$140.00 ♣
CGN-2009-015	1000mL System, PES, 0.22µm	12	<del>\$254.00</del>	\$203.20 ♣
CGN-2009-007V	500mL System, PVDF, 0.22µm	12	<del>\$178.50</del>	\$142.80 ♣
CGN-2009-015V	1000mL System, PVDF, 0.22µm	12	<del>\$257.00</del>	\$205.60 ♣



CGN-2009-series

- ▶ High Flow Rates
- ▶ 0.22µm PES Membranes
- ▶ Graduations on Funnels and Flasks

### Vacuum Filtration Pump, Oil-Free

Compact vacuum filtration pumps designed for sample preparation in chemistry, microbiology, waste water control and other analytical processes. Diaphragm pumps offer a compact, high performance and easy-to-use solution which is perfect for both single and multiple filtrations. The functional, space-saving and innovative design with readily accessible, top-mounted power switch ensures convenient and quick operation.

#### Corrosion Resistant Design

Both models feature robust PTFE diaphragms and valves for excellent corrosion resistance in routine biology and chemistry lab applications. The CLS-4880-01 has an aluminum head and is well suited for aqueous and some organic solvents. The -03 incorporates a PTFE head to provide a full fluoropolymer flow path for maximum chemical resistance in the most challenging applications.

#### Quiet & Reliable

These pumps offer whisper-quiet operation, low vibration, and long service intervals: 10,000-15,000 operating hours in most applications.

**Ultimate Vacuum:** 75 Torr (100mbar)      **Free Air Capacity:** 14 lpm (0.5cfm)



CLS-4880-series

### Oil-Free, Vacuum Filtration Pump

Part No.	Description	Qty.	Price
CLS-4880-01	with Aluminum Head	1	\$990.00 *
CLS-4880-03	with PTFE Head	1	\$1,290.00 *

\*Not subject to discount.

† Reusable Glass / Plastics Prod. Line ♣ Consumable Prod. Line Ω EDU / Economical Pkg. Prod. Line



CG-3070-series

### Luer Lock Syringes

Borosilicate glass syringe has interchangeable barrels and plungers. Colored plunger ends identify the capacity of the syringe. Flanges are flat on two sides to prevent syringe from rolling. All sizes of syringes are equipped with a metal luer lock and permanently fused graduations. For needles see CG-3075.

#### Luer Lock Syringes

Part No.	Cap. (cc)	Subdivisions (cc)	Qty.	Price
<b>CG-3070-01</b>	2	1/10	1	<b>\$19.15 *</b>
<b>CG-3070-03</b>	5	1/5	1	<b>\$19.65 *</b>
<b>CG-3070-04</b>	10	1/5	1	<b>\$32.80 *</b>
<b>CG-3070-05</b>	20	1	1	<b>\$28.55 *</b>
<b>CG-3070-06</b>	30	1	1	<b>\$45.75 *</b>
<b>CG-3070-07</b>	50	2	1	<b>\$102.20 *</b>



CGN-2005-series

### Sterile Syringe Filters, NEST

NEST high quality syringe filters are individually wrapped and sterile. The standard range of filters are available in PVDF (polyvinylidene fluoride) and PES (polyethersulfone)

All filters are designed with Female Luer-Lock inlets and Male Luer-Slip outlets. Sterilized, non-pyrogenic and RNA- and DNA-free. The syringe filter housings are polypropylene.

**PVDF** – Extremely low protein-binding for filtration of non-aggressive aqueous and mild organic solutions or where maximizing protein recovery is important.

- gas filtration
- vapor filtration
- high temperature filtration

**PES** – Low affinity for proteins and extractables with substantially faster flow rates than PVDF; suitable for pre-filtration and filtration of buffers and culture media.

- sterile filtering protein solution
- tissue culture media filtration
- tissue culture additive filtration

#### Sterile, Individually Wrapped, Syringe Filters

Part No.	Material	Membrane Size (µm)	Dia. (mm)	Qty.	Price	SALE Price
<b>CGN-2005-005</b>	PVDF	0.22	13	50	<del>\$76.00</del>	<b>\$60.80 ♣</b>
<b>CGN-2005-009</b>	PVDF	0.45	13	50	<del>\$76.00</del>	<b>\$60.80 ♣</b>
<b>CGN-2005-007</b>	PVDF	0.22	25	50	<del>\$79.00</del>	<b>\$63.20 ♣</b>
<b>CGN-2005-011</b>	PVDF	0.45	25	50	<del>\$79.00</del>	<b>\$63.20 ♣</b>
<b>CGN-2005-013</b>	PES	0.22	13	50	<del>\$60.50</del>	<b>\$48.40 ♣</b>
<b>CGN-2005-017</b>	PES	0.45	13	50	<del>\$60.50</del>	<b>\$48.40 ♣</b>
<b>CGN-2005-015</b>	PES	0.22	25	50	<del>\$72.00</del>	<b>\$57.60 ♣</b>
<b>CGN-2005-019</b>	PES	0.45	25	50	<del>\$72.00</del>	<b>\$57.60 ♣</b>

\* Lab Supply Prod. Line ♢ Life Sciences Consumable Prod. Line

### Low Form, Griffin Beaker Starter Pack, Double Scale, PYREX®

- Five popular sizes per starter pack

An assortment of popular low form Griffin beakers. The pack consists of five beakers; **one each of the 50, 100, 250, 600 and 1000mL** capacities. Ideal for start-up requirements and customers who need a variety of beaker size but have limited lab space or glassware needs.

#### Beaker Starter Pack

Part No.	Description	Price
CG-8048-PACK	Low Form, Griffin Beakers	\$50.80 †



CG-8048-PACK

### Low Form, Griffin Beakers, Polypropylene

Low form polypropylene beakers are chemically resistant with printed graduations that show approximate volume. Steam autoclavable at 121°C.

#### Graduated Polypropylene Griffin Beakers

Part No.	Capacity (mL)	Qty.	Price
CG-1108-10	50	12	\$44.60 †
CG-1108-11	100	12	\$45.10 †
CG-1108-13	250	6	\$37.40 †
CG-1108-15	600	4	\$39.50 †
CG-1108-16	1000	3	\$29.95 †
CG-1108-17	2000	1	\$24.10 †



CG-1108-series

### Solution Bottles, 500mL, Polystyrene, Sterile

Solution bottles are ideal for storage of media, buffers, and other aqueous solutions. Bottles are manufactured from polystyrene and are e-beam sterilized. Feature heavy wall construction, graduations, concave shape and knurled cap for easy handling. Solution bottles are RNase- and DNase-free. Solution bottles have 20% additional headspace above stated volumes.

#### Polystyrene Solution Bottles

Part No.	Capacity (mL)	Neck Size (mm)	Qty.	Price	SALE Price
CGN-1152-0250	250	45	24	<del>\$96.50</del>	\$77.20 Ω
CGN-1152-0500	500	45	24	<del>\$114.00</del>	\$91.20 Ω
CGN-1152-1000	1000	45	12	<del>\$101.50</del>	\$81.20 Ω



CGN-1152-series

See bottle top filtration systems on page 27.

† Reusable Glass / Plastics Prod. Line ♣ Consumable Prod. Line Ω EDU / Economical Pkg. Prod. Line

Money-saving  
alternative to  
glass



CLS-1150-series

### Square Media Bottles, PETG, Sterile, Graduated

- Pyrogen-, DNase-, RNase- and particle-free
- Leak-proof, transparent and optically clear
- Freezable at -20°C, disposable and recyclable
- Gamma irradiated - sterility assurance level (SAL) 10<sup>-6</sup>
- 20% overhead space

Break-resistant, durable media bottles are manufactured from polyethylene terephthalate copolyester (PETG) and graduated to contain. They are square / octagonal with rounded edges for easy gripping. Caps are manufactured with polyethylene (HDPE) and come with security rings for tamper-evident sealing. Caps are liner-free and leak-proof. Bottles provide reduced permeability to both CO<sub>2</sub> and O<sub>2</sub>. **NOTE: bottles are not autoclavable.** Bottle Design: Patent US D535566S. Tamper-evident Cap Design: Patent US D561587S.

### Square Media Bottles with Graduations, Sterile

Part No.	Capacity (mL)	Thread Size	Qty.	Price
CLS-1150-0030	30	20-415	24	\$62.30 ◇
CLS-1150-0060	60	20-415	24	\$82.00 ◇
CLS-1150-0125	125	38-430	24	\$154.40 ◇
CLS-1150-0250	250	38-430	24	\$173.20 ◇
CLS-1150-0500	500	38-430	12	\$113.60 ◇
CLS-1150-1000	1000	38-430	12	\$161.05 ◇
CLS-1150-2000	2000	53-B	6	\$163.05 ◇



CGN-1150-series

### Square Media Bottles, PETG, Sterile, NEST

- Sterilized by E-Beam, SAL=10<sup>-6</sup>
- Non-pyrogenic, DNase- and RNase-free
- Temperature Range -80°C to 50°C

PETG bottles are suitable for handling and reagents and medium storing critical (protein/vaccine etc).

### Square Media Bottles, PETG, Sterile

Part No.	Capacity (mL)	Pack Qty.	Case Qty.	Price	SALE Price
CGN-1150-030	30	5	40	<del>\$80.50</del>	\$64.40 ♣
CGN-1150-060	60	6	48	<del>\$110.00</del>	\$88.00 ♣
CGN-1150-125	125	6	48	<del>\$145.00</del>	\$116.00 ♣
CGN-1150-250	250	6	48	<del>\$182.50</del>	\$146.00 ♣
CGN-1150-500	500	8	24	<del>\$131.00</del>	\$104.80 ♣
CGN-1150-1000	1000	4	12	<del>\$109.00</del>	\$87.20 ♣

\* Lab Supply Prod. Line ◇ Life Sciences Consumable Prod. Line

## Square Media Bottles, PET, Sterile, Graduated, NEST

- Break-resistant polyethylene terephthalate (PET)
- Transparency equivalent to glass
- Cap is high-density polyethylene (HDPE)
- Smooth surface, not easy to residue, easy to clean
- Good chemical resistance
- Suitable for sample collection of various liquid particle size test, high clean reagents, particle standard materials and standard samples
- Durable scale and white enamel marking area
- Excellent physical and mechanical properties over a wide temperature range
- Unique external thick collar design for easy sealing operation in experiments
- Sterile, DNase-, RNase- and pyrogen-free

Mainly used for storing and sampling active pharmaceutical ingredients and bulk intermediates. Also used for preparing and storing buffers and culture solutions and long-term storage of pH sensitive liquids.

### Square Media Bottles with Graduations, Sterile

Part No.	Capacity (mL)	Pack Qty.	Case Qty.	Price	SALE Price
CGN-1151-125	125	6	48	<del>\$88.50</del>	\$70.80 ♣
CGN-1151-250	250	6	48	<del>\$105.50</del>	\$84.40 ♣
CGN-1151-500	500	8	24	<del>\$93.50</del>	\$74.80 ♣
CGN-1151-1000	1000	4	12	<del>\$84.50</del>	\$67.60 ♣

## Polypropylene Carboys, Autoclavable, 83mm Closure

Carboys made from white, medical-grade, polypropylene resin conforming to USP Class VI. They can be used for storing, dispensing and transporting large amounts of culture media, distilled water and other solutions. Graduations are molded-in. Includes 83mm, white, leak-proof, polypropylene closure.

### Carboys with Handles

Part No.	Capacity (L)	Qty.	Price
CG-871-10	10	1	\$101.35 †
CG-871-20	20	1	\$141.10 †

### Carboys with Handles and Spigots

Part No.	Capacity (L)	Qty.	Price
CG-870-10	10	1	\$176.90 †
CG-870-20	20	1	\$213.30 †



CGN-1151-series



CG-871-series



CG-870-series

† Reusable Glass / Plastics Prod. Line ♣ Consumable Prod. Line Ω EDU / Economical Pkg. Prod. Line

CG-8242-series  
Single Cylinders

### Graduated Cylinders, Single Metric Scale, "To Deliver", PYREX®

Pyrex® cylinder calibrated "To Deliver". Polyethylene bumper guards are supplied with sizes 25 through 2000mL. The 5 and 10mL have an enlarged funnel-shaped top for ease of filling. The 10 and 25mL sizes are comparatively short to provide increased stability. The 100mL size may be used for some ASTM distillation tests. Scale is durable white ceramic enamel. Designed from ASTM Specification E1272, Style 1, Class B requirements.

#### Class B Graduated Cylinders, Single Scale

Part No.	Cap. (mL)	Qty.	Price
CG-8242-5	5	1	\$36.90 †
CG-8242-10	10	1	\$24.25 †
CG-8242-25	25	1	\$34.35 †
CG-8242-50	50	1	\$35.70 †
CG-8242-100	100	1	\$42.70 †
CG-8242-250	250	1	\$59.05 †
CG-8242-500	500	1	\$82.45 †
CG-8242-1L	1000	1	\$103.10 †
CG-8242-2L	2000	1	\$169.50 †
CG-8242-4L	4000	1	\$428.45 †



CG-8242-PACK

### Graduated Cylinders Starter Pack, Single Metric Scale, "To Deliver", PYREX®

The starter pack contains an assortment of the most popular cylinders. Pack consists of one each: **10, 25, 50, 100 and 250mL**. Ideal for start-up requirements or customers who need a variety of cylinder sizes, but have limited lab space or glassware needs.

#### Cylinder Starter Pack

Part No.	Description	Qty.	Price
CG-8242-PACK	Graduated Cylinder Starter Pack	1	\$228.35 †

\* Lab Supply Prod. Line ◇ Life Sciences Consumable Prod. Line



### Graduated Erlenmeyer Flasks Starter Pack, Narrow Mouth, Heavy Duty Rims, PYREX®

An assortment of our popular size Erlenmeyer flasks. The pack consists of five flasks (one each) in sizes of 50, 125, 250, 500 and 1000mL.

#### Erlenmeyer Flask Starter Pack

Part No.	Description	Qty.	Price
CG-8496-PACK	Erlenmeyer Flask Starter Pack	1	\$71.60 †



CG-8496-PACK

### Erlenmeyer Flasks, Narrow Mouth, Heavy Duty Rim, Graduated, PYREX®

Approximate graduations are in durable white enamel. An extra large marking space is also provided. Heavy, durable top tooling.

#### Narrow Mouth Erlenmeyer Flasks with Graduations

Part No.	Capacity (mL)	Qty.	Price
CG-8496-10	10	12	\$155.85 †
CG-8496-25	25	12	\$96.15 †
CG-8496-50	50	12	\$93.60 †
CG-8496-125	125	12	\$90.30 †
CG-8496-250	250	12	\$86.25 †
CG-8496-300	300	12	\$104.55 †
CG-8496-500	500	6	\$53.90 †
CG-8496-1L	1,000	6	\$87.50 †
CG-8496-1XL	1,500	1	\$130.65 †
CG-8496-2L	2,000	1	\$34.40 †
CG-8496-4L	4,000	1	\$108.95 †
CG-8496-6L	6,000	1	\$200.20 †



CG-8496-series

### Transfer Forceps

- 5-inch (127 mm)
- HIPS - high impact polystyrene

Part No.	Material	Color	Qty.	Price
CGE-1651-001	high impact polystyrene	aquamarine	1	\$3.95 Ω



See stainless tweezers on the website.

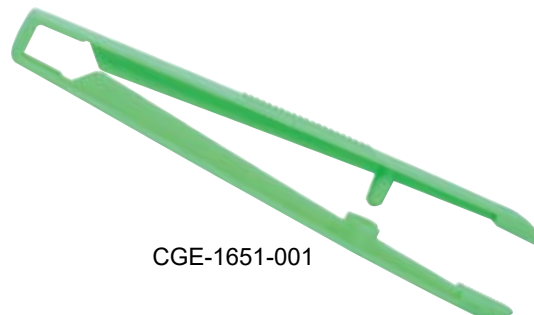

CGE-1651-001

† Reusable Glass / Plastics Prod. Line ♣ Consumable Prod. Line Ω EDU / Economical Pkg. Prod. Line

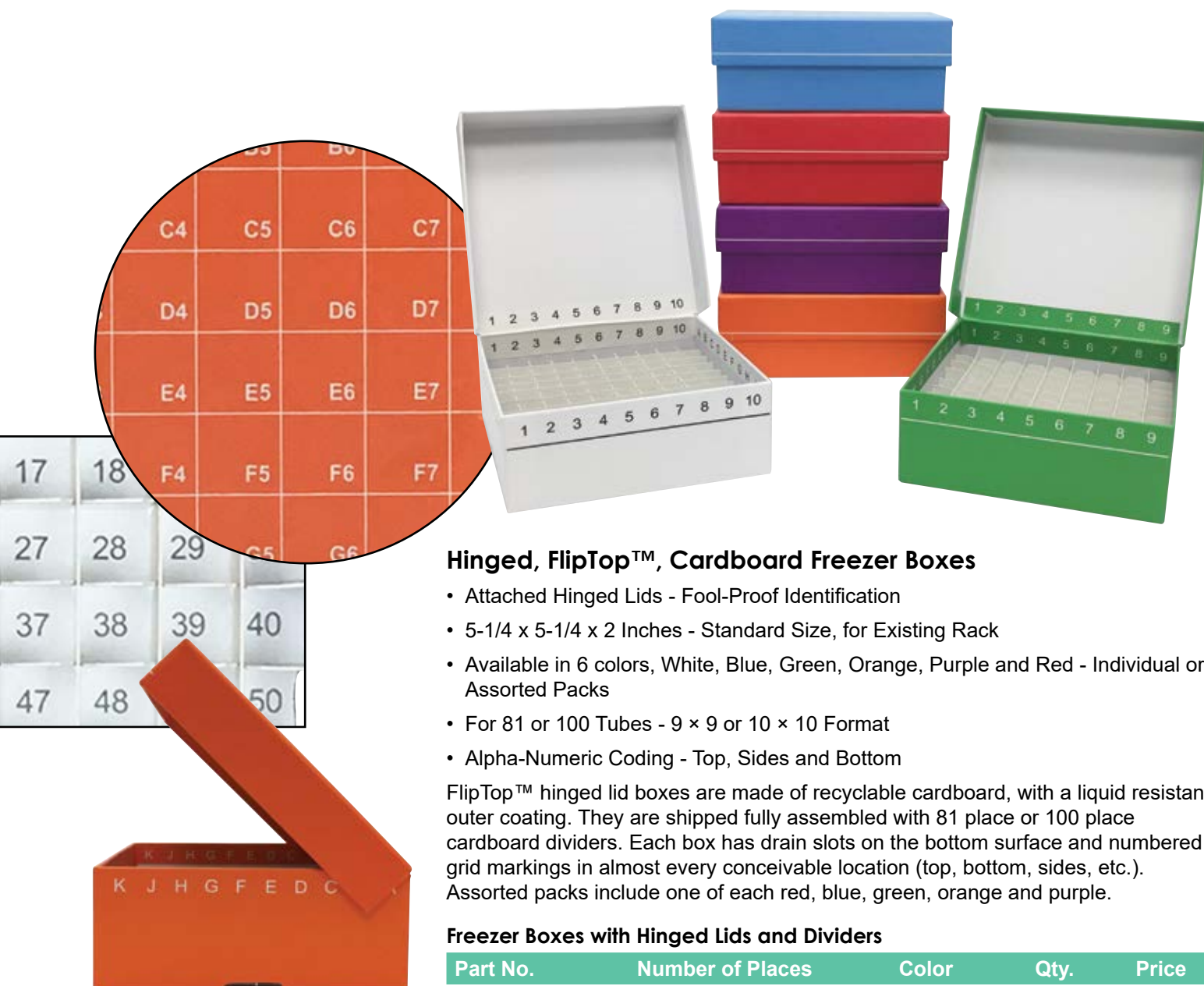

CLS-1197-series

### Hinged, FlipTop™, Cardboard Freezer Boxes

- Attached Hinged Lids - Fool-Proof Identification
- 5-1/4 x 5-1/4 x 2 Inches - Standard Size, for Existing Rack
- Available in 6 colors, White, Blue, Green, Orange, Purple and Red - Individual or Assorted Packs
- For 81 or 100 Tubes - 9 × 9 or 10 × 10 Format
- Alpha-Numeric Coding - Top, Sides and Bottom

FlipTop™ hinged lid boxes are made of recyclable cardboard, with a liquid resistant outer coating. They are shipped fully assembled with 81 place or 100 place cardboard dividers. Each box has drain slots on the bottom surface and numbered grid markings in almost every conceivable location (top, bottom, sides, etc.). Assorted packs include one of each red, blue, green, orange and purple.

### Freezer Boxes with Hinged Lids and Dividers

Part No.	Number of Places	Color	Qty.	Price
CLS-1197-081	81	white	5	\$18.60 ◇
CLS-1197-081B	81	blue	5	\$19.35 ◇
CLS-1197-081G	81	green	5	\$19.35 ◇
CLS-1197-081H	81	orange	5	\$19.35 ◇
CLS-1197-081P	81	purple	5	\$19.35 ◇
CLS-1197-081R	81	red	5	\$19.35 ◇
CLS-1197-081A	81	assorted	5	\$19.35 ◇
CLS-1197-100	100	white	5	\$18.60 ◇
CLS-1197-100B	100	blue	5	\$19.35 ◇
CLS-1197-100G	100	green	5	\$19.35 ◇
CLS-1197-100H	100	orange	5	\$19.35 ◇
CLS-1197-100P	100	purple	5	\$19.35 ◇
CLS-1197-100R	100	red	5	\$19.35 ◇
CLS-1197-100A	100	assorted	5	\$19.35 ◇

\* Lab Supply Prod. Line ◇ Life Sciences Consumable Prod. Line

### Cardboard Freezer Boxes with Dividers

- Durable and treated to resist moisture
- Use in temperatures down to -196°C

Durable storage boxes made of cardboard treated with a moisture-repellent to protect from the effects of liquid nitrogen and condensation from freezer equipment. Boxes can withstand temperatures as low as -196°C. Small drain holes in the bottom corners allow drainage of excess moisture. Designed to be compatible with most standard upright rack systems. Available white or yellow and in a variety of sizes / configurations to best match your needs.



CLS-1198-W81



### Cardboard Freezer Boxes, 81-Cell with Dividers

Part No.	Color	Dimensions (in)	Qty.	Price
CLS-1198-W81	white	5-1/4 x 5-1/4 x 2	1	\$3.70 ◊
CLS-1198-W82	yellow	5-1/4 x 5-1/4 x 2	1	\$3.70 ◊

### Upright Style Freezer Racks for Two-inch Boxes

For -20° to -80° Freezers

Upright freezer drawer racks are for standard two-inch, cardboard, plastic (polycarbonate) or metal (stainless steel or aluminum) boxes. High quality upright freezer racks are constructed of corrosion resistant stainless steel, including handles and identification card holders. Racks offer a more organized system for storage and retrieval of samples. They facilitate both access to and storage of samples without having to remove the whole rack from the freezer.



CLS-3792-series

### Upright Style Freezer Racks for Two-inch Boxes

Part No.	No. of Boxes (Config.)	Overall Dimensions (in)	Qty.	Price
CLS-3792-001	9 (3L x 3H)	16-15/16L x 5-1/2W x 6-5/8H	1	\$92.30 *
CLS-3792-003	12 (3L x 4H)	16-15/16L x 5-1/2W x 8-7/8H	1	\$86.00 *
CLS-3792-005	12 (4L x 3H)	21-5/8L x 5-1/2W x 6-5/8H	1	\$94.10 *
CLS-3792-007	15 (3L x 5H)	16-15/16L x 5-1/2W x 11H	1	\$112.90 *
CLS-3792-009	16 (4L x 4H)	21-5/8L x 5-1/2W x 8-7/8H	1	\$115.60 *
CLS-3792-010	20 (4L x 5H)	21-5/8L x 5-1/2W x 11H	1	\$185.50 *
CLS-3792-011	25 (5L x 5H)	26-3/4L x 5-1/2W x 11H	1	\$180.10 *
CLS-3792-013	24 (4L x 6H)	21-5/8L x 5-1/2W x 12-5/8H	1	\$180.00 *
CLS-3792-015	20 (5L x 4H)	26-3/4L x 5-1/2W x 8-7/8H	1	\$173.30 *



CLS-3792-E009

### Lightweight, Upright Style Freezer Racks for Two-inch Boxes

Fins replace full shelves for less frost build-up and lighter weight.

Improved design yields a lighter-weight, but heavy-duty, corrosion-resistant, stainless steel rack with fins instead of shelves for standard two-inch boxes.

### Upright Style Freezer Racks for Two-inch Boxes

Part No.	No. of Boxes (Config.)	Overall Dimensions (in)	Qty.	Price
CLS-3792-E009	16 (4L x 4H)	21-5/8"L x 5-1/2"W x 8-7/8"H	1	\$115.60 *

Fins for 2-inch boxes

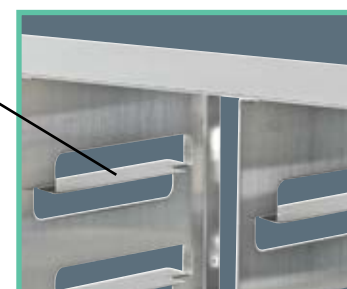

† Reusable Glass / Plastics Prod. Line ♣ Consumable Prod. Line Ω EDU / Economical Pkg. Prod. Line



CG-1790-B-series



CG-1790-P-series



CG-1790-R-series



CG-1790-T-series

## Aurelia Powder-Free Nitrile Examination Gloves

- Better elasticity than vinyl
- Better puncture resistance than latex or vinyl
- Better abrasion resistance than chloroprene
- Reduced likelihood of allergic reaction
- Powder-free leaves no residue

### Glove SPECIAL!

**4th Box  
FREE!\***

See rules below.

Part No.	Description	Qty.	Price
<b>Aurelia Bold Examination Gloves, Black</b> 4.5 mil Palm and 5 mil Finger Thickness, Fingers Textured			
CG-1790-B01	Extra Small	100	\$10.50 *
CG-1790-B02	Small	100	\$10.50 *
CG-1790-B03	Medium	100	\$10.50 *
CG-1790-B04	Large	100	\$10.50 *
CG-1790-B05	Extra Large	100	\$10.50 *
<b>Aurelia Protégé Examination Gloves, Trans-Blue</b> 3.2 mil Palm & 4 mil Finger Tip Thickness, Fingers Textured			
CG-1790-P01	Extra Small	100	\$10.50 *
CG-1790-P02	Small	100	\$10.50 *
CG-1790-P03	Medium	100	\$10.50 *
CG-1790-P04	Large	100	\$10.50 *
CG-1790-P05	Extra Large	100	\$10.50 *
<b>Aurelia Robust Examination Gloves, Blue</b> 5 mil Palm and 6 mil Finger Thickness, Fingers Textured the Full Length			
CG-1790-R02	Small	100	\$10.50 *
CG-1790-R03	Medium	100	\$10.50 *
CG-1790-R04	Large	100	\$10.50 *
CG-1790-R05	Extra Large	100	\$10.50 *
<b>Aurelia Transform Examination Gloves, Trans-Blue</b> 3.2 mil Palm & 4 mil Finger Tip Thickness, Fingers Textured			
CG-1790-T02	Small	200	\$19.50 *
CG-1790-T03	Medium	200	\$19.50 *
CG-1790-T04	Large	200	\$19.50 *
CG-1790-T05	Extra Large	200	\$19.50 *



**4th Box  
FREE!**

**Buy three boxes of the same style gloves and receive a fourth box, of that same style, for free. Sorry, no mix and match among styles.**

\*Rules: Offer limited to CG-1790-B-, CG-1790-P-, CG-1790-R- and CG-1790-T-series' Aurelia gloves. Offer valid from 1/3/2024 through 6/30/24. Purchaser must specify promo code CM01124 when placing the order.

**YOUR ORDER:** In the notes section of your shopping cart, please indicate the glove size of the free boxes you qualify for. A revised order acknowledgment, including the free boxes will be sent to you.

Valid on US and Canadian purchases only. May not be combined with any other offer or discount. This offer is non-transferable and void where prohibited by law or company policy. Offer is subject to Chemglass Life Sciences' standard terms, conditions and contracts. Offer not valid through distributors.

\* Lab Supply Prod. Line ◇ Life Sciences Consumable Prod. Line

### Liner for Laboratory Benchtops, Floors and Carts

- Economically absorbs and retains spills
- Soft, durable and easily cut to size

Absorbent liner keeps spills from spreading and protects benchtops, floors and carts. Cushions surfaces while absorbing liquids. Made of highly absorbent three-ply tissue with a waterproof polypropylene backing that is resistant to most chemicals.

#### Absorbent Liner Bench Protector

Part No.	Size	Qty.	Price
CGE-1150-001	20 in. x 50 feet	1 roll	\$49.50 Ω



CGE-1150-001

### High Performance Ice Buckets with Lids

- Expanded urethane laboratory ice buckets are lightweight, durable and non-sweating
- Able to withstand a wide temperature range: -196°C (-320°F) to 100°C (212°F)
- Impervious to moisture and odors
- Features convenient pour spout, drip-proof rims and fill line indicator
- Includes snug-fitting lid that stores neatly under base when not in use
- Lightly textured non-slip finish and raised edge provides secure transport
- Available in 2.5L and 4.0L sizes, each in four colors; blue, black, red and green

Superior insulating properties combined with high chemical resistance make these ice buckets compatible not only with wet ice, but also with ultra-low temperature materials including dry ice, salt slurries, dry ice methanol slurries, or liquid nitrogen.



CLS-17099-series

#### High Performance Ice Buckets with Lids

Part No.	Size (L)	Color	Qty.	Price
CLS-17099-201	2.5	blue	1	\$132.05 *
CLS-17099-202	2.5	black	1	\$132.05 *
CLS-17099-203	2.5	red	1	\$132.05 *
CLS-17099-204	2.5	green	1	\$132.05 *
CLS-17099-401	4	blue	1	\$135.30 *
CLS-17099-402	4	black	1	\$135.30 *
CLS-17099-403	4	red	1	\$135.30 *
CLS-17099-404	4	green	1	\$135.30 *



High Performance Ice Pans with Lids also available.  
See CLS-17100-series on the website.



† Reusable Glass / Plastics Prod. Line ♣ Consumable Prod. Line Ω EDU / Economical Pkg. Prod. Line

## LABeler™ Handheld Laboratory Printer



CG-4034-10

- Lightweight, handheld operation
- Variety of label tapes for many tube sizes
- Built-in cutter – no need for scissors
- Prints a variety of barcodes
- “Ultra-Low” tape for liquid nitrogen storage

Proper identification of scientific samples is often a key objective of the research laboratory. The process of writing on sample tubes and containers can be messy and unreliable. It can also be difficult to find the time to access a computer and design a layout for expensive ink jet labels. The LABeler™ Lab Printer provides the convenience of a lab pen with the benefits of a large desktop printer. Simply type in the desired copy using the 50+ button key pad and press the print key... within seconds your label can be cut by pressing the cut lever and is then ready for application.

With over 15 available sizes, colors & material combinations, the LABeler™ is ideal for label identification of any laboratory vessel for nearly any laboratory application. Standard label tapes can be autoclaved, boiled or even frozen to temperatures as low as -50°C. Special Ultra-Low label tapes are also available for storage in -80°C environments or for liquid nitrogen applications. **Includes one, 12mm wide white tape with black print (CG-4034-20).**

**NOTE:** Printer requires six AA batteries. They must be purchased separately.



Tapes available in a variety of sizes and colors.

### LABeler Handheld Laboratory Printer

Part No.	Capacity (L)	Qty.	Price
CG-4034-10	LABeler™ Lab Printer with 115V Power Supply	1	\$186.45 *
CG-4034-14	Power Supply ONLY, for LABeler™ Printer	1	\$47.45 *

### Printer Tapes

Part No.	Description	Width (mm)	Length (ft)	Qty.	Price
CG-4034-16	White with Black Print	6	26	1	\$30.90 *
CG-4034-18	Clear with Black Print	12	26	1	\$32.05 *
CG-4034-20	White with Black Print	12	26	1	\$34.30 *
CG-4034-22	Clear with Black Print	12	26	1	\$36.60 *
CG-4034-24	Yellow with Black Print	12	26	1	\$28.60 *
CG-4034-26	Red with White Print	12	26	1	\$28.60 *
CG-4034-28	Blue with White Print	12	26	1	\$28.60 *
CG-4034-30	Green with White Print	12	26	1	\$28.60 *
CG-4034-32	White with Black Print	24	26	1	\$42.35 *
CG-4034-34	Clear with Black Print	24	26	1	\$46.90 *
CG-4034-36	ULTRA LOW TEMP, White with Black Print	12	20	1	\$32.05 *
CG-4034-38	ULTRA LOW TEMP, White with Black Print	24	20	1	\$46.90 *

\* Lab Supply Prod. Line ♦ Life Sciences Consumable Prod. Line

### Sealing Films, SEALPLATE®

- Functional temperature range from -40° to +120°C
- Available sterile or non-sterile

SealPlate 50µm thickness polyester sealing films minimize evaporation, prevent spillage and contamination between wells, and provide a secure seal, not just a cover. Secure sealing of all wells eliminates “edge effects” in sensitive ELISA assays. SealPlate sealing films can also be used with tissue culture plates for short-term storage, incubation and containment of biohazards. SealPlate sealing films are non-pierceable. Each SealPlate sealing film measures 79.4 x 146.1mm.

#### Sealing Films

Part No.	Description	Qty.	Price
CLS-4001-001	Sealing Film, SealPlate, Non-Sterile	100	\$65.45 ◇
CLS-4001-003	Sealing Film, SealPlate, Sterile	100	\$89.20 ◇
CLS-4001-00R	Film Sealing Plate Roller Only	1	\$40.80 ◇

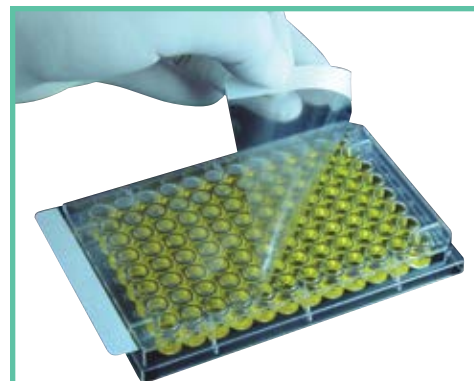

SealPlate Sealing Films

*Use the accessory plate roller to assure a secure and uniform seal around all wells.*

### Sealing Films for Real Time PCR, THERMALSEAL RT™

- “Brilliant” ultra-high optical clarity
- Heat resistant; recommended for temperatures from -40° to +120°C
- Certified DNase-, RNase- and nucleic-acid-free

ThermalSeal RT 50µm thick sealing films combine optically transparent polyester sealing film with a strong, ultra-smooth, non-absorbing, non-fluorescing, **medical-grade adhesive for superior performance in real-time PCR applications**. In place of the customary paper backing, ThermalSeal RT sealing films have a plastic liner which is easily removed before use and contributes smoothness and extreme optical clarity to the adhesive. Dimensions are 79.4 x 142.9mm for sealing PCR plates. Length between the perforations with end tabs removed is 121.9mm.

Completing application of sealing films by pressing with the accessory plate roller assures a secure, uniform seal around all wells.

#### Sealing Films for Real Time PCR

Part No.	Description	Qty.	Price
CLS-4001-005	Sealing Films, 50µm Thick	100	\$173.30 ◇
CLS-4001-00R	Film Sealing Plate Roller Only	1	\$40.80 ◇

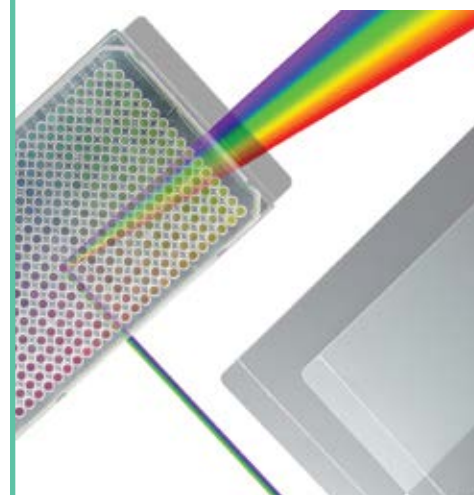

ThermalSeal RT

### 4" Rubber Roller for Sealing Film

- Designed for sealing film or foil on PCR plates
- Made of medium-hard rubber
- Heavy-duty handle with a comfortable grip

#### Rubber Roller for Sealing Film

Part No.	Description	Qty.	Price
CLS-1396-001	4" Roller, Rubber, Sealing Film	1	\$54.00 *



CLS-1396-001

† Reusable Glass / Plastics Prod. Line ♣ Consumable Prod. Line Ω EDU / Economical Pkg. Prod. Line

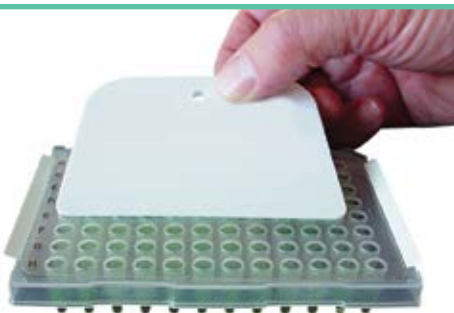

ThermalSeal A

Completing application of sealing films by pressing with accessory film-sealing paddle assures a secure, uniform seal around all the wells. The paddle fits within the edge of raised-rim plates.

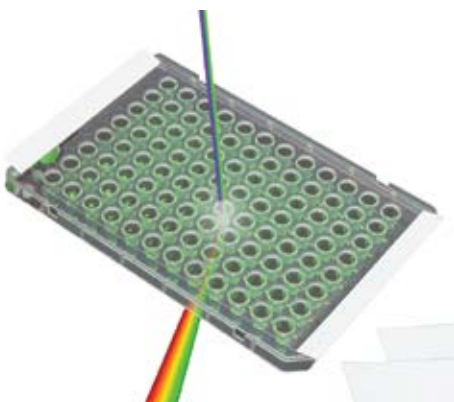

ThermalSeal RTS

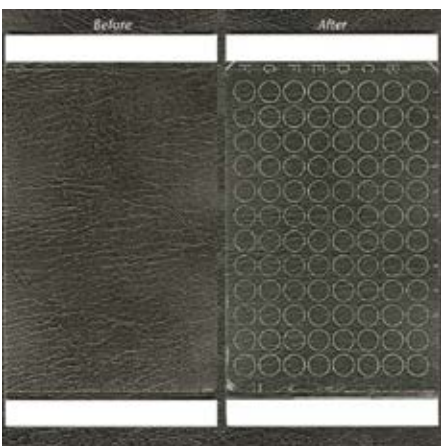

### Sealing Films for Classic PCR, THERMALSEAL A™

- Stronger and thicker 50µm adhesive layer for a secure seal
- Heat resistant; recommended temperatures from -40°C to +125°C
- Can be used with raised-rim PCR plates and standard plates
- Two end tabs which are perforated for easy removal
- Certified DNase-, RNase- and nucleic-acid-free

ThermalSeal A sealing films are an advanced version of classic ThermalSeal sealing films for PCR. ThermalSeal A films consist of 50µm thick clear polypropylene with a thicker 50µm layer of a stronger adhesive formulated for improved protection against evaporation and leakage during thermal cycling.

**Intended for non-realtime PCR applications.** Dimensionally cut for a universal fit yields a secure seal for both raised-rim and flat top PCR plates. Two end tabs allow for easy positioning of the film on the plate but are perforated for easy removal. Dimensions with end tabs are 135.5 x 77.8mm; length without end tabs is 118.1mm with 45° corners. Each package includes one film sealing paddle that also works with raised-rim plates.

### Sealing Films for Classic PCR

Part No.	Description	Qty.	Price
CLS-4001-006	Sealing Film, ThermalSeal A, Non-Sterile	100	\$96.10 ◇
CLS-4001-00P	Film Sealing Paddle Only	5	\$8.30 ◇

### Sealing Films for QPCR, Storage & Crystallization, THERMALSEAL RTS™

- Optically clear with minimal auto-fluorescence
- Chemically inert; no extractables except at extreme pH
- DMSO-resistant for HTS and Certified DNase-, RNase- and nucleic-acid-free
- Heat resistant; recommended for temperatures from -70° to +100°C
- Fit within raised plate rim to prevent loss of seal due to film lifting
- Silicone adhesive forms the strongest available seal for evaporation prevention
- Non-tacky adhesive layer simplifies handling of film prior to sealing

ThermalSeal RTS sealing films are 50µm polyolefin films with 50µm inert encapsulated silicone adhesive. **Especially suited for real-time qPCR, storage and protein crystallization applications.** The encapsulated silicone adhesive is non-tacky until pressed against the sealing surface, at which time adhesive is released only in sealing areas to form the strongest available heat-resistant seal around each well. Adhesive on non-sealing areas of the film, such as directly over sample wells, remains encapsulated and inert. ThermalSeal RTS films are sized to fit within the edges of raised-rim 96-well plates. Consistent high optical clarity makes possible reproducible, reliable, and consistent DNA amplification measurements and crystal detection. Two end tabs assist in positioning films on plates. Easy removal of the end tabs at perforated boundaries prevents lifting and higher evaporation rates that can occur with films that overlap the plate rim. Dimensions: 76.2 x 133.4mm, length with end tabs removed is 113.0mm.

### Sealing Films for QPCR

Part No.	Description	Qty.	Price
CLS-4001-007	Sealing Film, ThermalSeal RTS, Non-Sterile	100	\$232.80 ◇
CLS-4001-00P	Film Sealing Paddle Only	5	\$8.30 ◇

\* Lab Supply Prod. Line ◇ Life Sciences Consumable Prod. Line



**Sealing Films, ALUMASEAL 96™** (Replaces Corning® / Costar® # 6570)

- Fits inside rim of raised-rim plate
- Heat and cold resistant: recommended for temperatures from -40° to +150°C
- Certified DNase-, RNase- and nucleic-acid-free

A 38µm thick aluminum foil sealing film for use with 96-well plates. Fits inside the rim of raised-rim plates. AlumaSeal 96™ sealing films have one partial-width end tab with no perforations. Pierceable. Dimensions are 127 x 78mm (including single 9.5mm end tab).

\*Completing application of AlumaSeal 96™ sealing films by pressing with accessory film-sealing paddle assures a secure, uniform seal around all the wells. The paddle fits within the rim of a raised-well plate.



CLS-4001-009

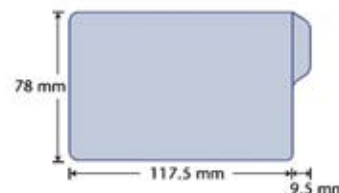

**Sealing Films**

Part No.	Description	Qty.	Price
CLS-4001-009	Sealing Film, AlumaSeal 96, Non-Sterile	100	\$84.80 ◇
CLS-4001-00P	Film Sealing Paddle Only	5	\$8.30 ◇

**Sealing Films, ALUMASEAL 384™** (Replaces Corning® / Costar® # 6569)

- Fits inside rim of raised-rim plate
- Heat and cold resistant: recommended for temperatures from -40° to +150°C
- Certified DNase-, RNase- and nucleic-acid-free

A 38µm thick aluminum foil sealing film for 384-well plates. Fits inside the rim of raised-rim plates. One partial-width end tab with no perforations. Pierceable. Dimensions are 137.3 x 82.5mm (including single 13.5mm end tab).



ALUMASEAL 384  
CLS-4001-011

**Sealing Films**

Part No.	Description	Qty.	Price
CLS-4001-011	Sealing Film, AlumaSeal 384, Non-Sterile	100	\$88.25 ◇
CLS-4001-00R	Sealing Film Plate Roller Only	1	\$40.80 ◇

*Use the accessory plate roller to assure a secure and uniform seal around all wells.*

**Sealing Films for Cell and Tissue Culture, AERASEAL™**

- Non-cytotoxic, highly gas permeable
- Easily pierceable with pipet tips for sample recovery
- Recommended for temperatures from -20° to +80°C

A 114µm thick hydrophobic porous sealing film with medical-grade adhesive for tissue culture plates, bio-blocks, and 96-well plates where gas exchange is necessary for cell or bacterial growth. Sealing films minimize cross-contamination, spillage and evaporation. They allow uniform air and CO<sup>2</sup> exchange for all wells, unlike plate lids which favor exchange for wells near the plate edges. Dimensions: 82.6 x 142.9mm for standard-size tissue culture plates.

For tissue culture plates, bio-blocks, and 96-well plates where gas exchange is necessary for cell or bacterial growth.

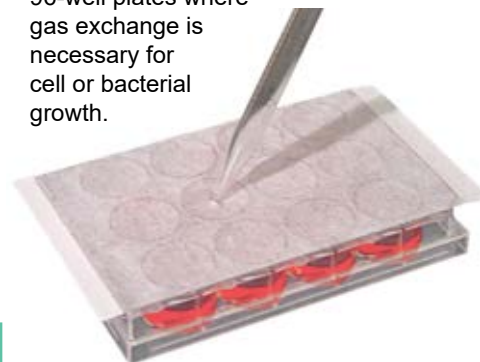

CLS-4001-series

**Sealing Films for Cell and Tissue Culture**

Part No.	Description	Qty.	Price
CLS-4001-013	Sealing Film, AeraSeal, Non-Sterile	100	\$103.20 ◇
CLS-4001-015	Sealing Film, AeraSeal, Sterile 25/Bag	50	\$70.35 ◇
CLS-4001-00R	Sealing Film Plate Roller Only	1	\$40.80 ◇

Completing application of sealing films with the accessory plate roller assures a secure, uniform seal around all wells.

† Reusable Glass / Plastics Prod. Line ♣ Consumable Prod. Line Ω EDU / Economical Pkg. Prod. Line

CLS-1906-01  
CLS-1906-02



### Autoradiography Film, BluBlot HS

- Ideal for chemiluminescence and suitable for use with 14C, 32P, 33P, 125I, 35S
- Compatible with automatic processors
- High contrast, reduced background, double emulsion

BluBlot™ HS is a high quality, blue sensitive film that is ideal for a wide range of electrophoretic and autoradiography applications. It can be used with calcium tungstate or blue-emitting rare-earth screens. BluBlot™ HS exhibits excellent sensitivity and contrast characteristics and is coated on both sides for improved consistency and overall performance. It reliably produces sharp, bright images that are easily visualized and suitable for publication. 100 sheets per box.

#### BluBlot HS Autoradiography Film

Part No.	Size (in.)	Qty.	Price
CLS-1906-01	5 x 7	100	\$95.75 ◇
CLS-1906-02	8 x 10	100	\$126.25 ◇

CLS-1915-113  
CLS-1915-115



All films are packed in light-safe, dispenser boxes of 100 sheets

### Autoradiography Film, Western Blotting, Blu-Lite UHC

Blu-Lite UHC™ film is formulated for an optimized balance of high sensitivity and low background making it ideal for all autoradiographic and electrophoretic applications. Excellent sensitivity and contrast characteristics, with both sides coated (double emulsion) for improved consistency and overall performance.

Films reliably produce sharp images which allow for maximum DNA visualization and unsurpassed clarity. Compatible with automatic processors and manual development methods, Blu-Lite UHC™ compares directly with films costing 3-5 times as much. Shelf life of 2 years from date of production. 100 sheets per box.

#### BluBlot UHC, Western Blotting, Autoradiography Film

Part No.	Size (in.)	Qty.	Price
CLS-1915-113	5 x 7	100	\$105.70 *
CLS-1915-115	8 x 10	100	\$143.50 *



The patented Heathrow eCount is a simple to use colony counter for counting cells in microbiology applications or tissue culture. This unit combines a multifunction electronic counter with a black Sharpie® pen for counting and marking to prevent missing or double-counting colonies in a Petri dish.

### Hand Held Colony Counter with Easy to Use Touch Controls

- Lightweight, ergonomic body balanced for easy manipulation
- Count up / down verification, enables you to confirm you counts
- Thumb button for use as a digital tally counter
- Easily verify each count with either an audible beep or LED flash
- Displays totals for up to 32 individual counts or zones
- Quick and easy to change between different colored markers
- Multi-functional counter can be turned off allowing the unit be used for writing
- Up to 999 colonies per zone helps simplify the counting process
- Weighted stand for bench top use
- Long Life – CR1225 3.0 V Lithium battery
- 5-year warranty - \*not including battery

#### eCount Hand Held Colony Counter

Part No.	Price
CLS-1802-C-001	\$277.60 *

\* Lab Supply Prod. Line ◇ Life Sciences Consumable Prod. Line

## Safety Spill Trays Help Contain Spills and Aid in Cleanup

- Acid-resistant safety spill trays
- Easy-to-clean covered corners (unless otherwise noted)
- Great for trays, drawers and shelf liners

Constructed of chemical-resistant 3/16" thick virgin polyethylene except for CG-1988-02 and CG-1988-03, which are welded polypropylene. Trays are designed to safely contain accidental spills. Unless otherwise noted, they are rotationally molded, one-piece design with smooth, covered corners; no welded joints that can leak, break off or trap contaminants.

### Spill Trays

Part No.	Dimensions LxWxH (in)	Material	Qty.	Price
CG-1949-X-15	12 x 12 x 2	polyethylene	1	\$91.85 *
CG-1988-A-02	14 x 14 x 2	polyethylene	1	\$100.10 *
CG-1988-A-04	17 x 14 x 2	polyethylene	1	\$104.65 *
CG-1949-X-25	19 x 12 x 2	polyethylene	1	\$103.50 *
CG-1988-A-06	19 x 16 x 2	polyethylene	1	\$106.75 *
CG-1988-A-08	19 x 18 x 2	polyethylene	1	\$109.95 *
CG-1988-A-09	21 x 15 x 2	polyethylene	1	\$109.95 *
CG-1988-A-10	21 x 19 x 2	polyethylene	1	\$114.45 *
CG-1988-A-12	22 x 19 x 2 Fits 24" Cabinets	polyethylene	1	\$114.45 *
CG-1988-A-14	30 x 18 x 2	polyethylene	1	\$119.80 *
CG-1988-A-16	31 x 16 x 2	polyethylene	1	\$119.80 *
CG-1988-A-18	34 x 19 x 2 Fits 36" Cabinets	polyethylene	1	\$122.85 *
CG-1988-A-20	38 x 14 x 2 Fits Most Flammable Cabinets	polyethylene	1	\$123.85 *
CG-1988-A-22	46 x 19 x 2	polyethylene	1	\$145.95 *

### Spill Trays for Reactors

Part No.	Dimensions LxWxH (in)	Material	Qty.	Price
CG-1988-01	17 x 22 x 2 Fits Reactor Frame: CG-1950-100 Capacity: 6L	polyethylene	1	\$199.30 *
CG-1988-02	27 x 28-1/2 x 3 Welded Seams, Fits Reactor Frame: CG-1951-100 Capacity: 37L	polypropylene	1	\$206.95 *
CG-1988-03	23-5/8 x 23-5/8 x 4 Welded Seams, Fits Reactor Frames: CG-1965-150 & CG-1965-X-150 Capacity: 37L	polypropylene	1	\$193.05 *



Safety Spill Trays contain spills and aid in cleanup.



Coved Corners for easy cleaning.

Custom Sizes Available!



Reactor Sizes!

## PTFE Magnetic Stir Bars, Octagonal Cross Section

Octagon cross-section having a molded-in pivot ring manufactured with FDA-grade and USP Class VI PTFE. The PTFE coated Alnico magnet permits magnetic agitation without contamination. See CG-2001-50 for Stir Bar Kits.



CG-2001-series



CG-2001-50

**Kit includes:** 6ea CG-2001-01, 6ea CG-2001-02, 2ea CG-2001-04, 3ea CG-2001-09, 1ea CG-2001-08, 1ea CG-2001-13, 1ea CG-2001-17

### Individual, Octagonal Cross Section, PTFE, Magnetic Stir Bars

Part No.	Length x Dia. (mm)	Length x Dia. (in.)	Qty.	Price
CG-2001-01	12.7 x 3.18	1/2 x 1/8	1	\$5.40 *
CG-2001-02	12.7 x 7.93	1/2 x 5/16	1	\$5.75 *
CG-2001-03	12.7 x 9.52	1/2 x 3/8	1	\$6.50 *
CG-2001-04	15.9 x 7.93	5/8 x 5/16	1	\$5.75 *
CG-2001-05	15.9 x 9.52	5/8 x 3/8	1	\$7.55 *
CG-2001-06	22 x 8	5/8 x 5/16	1	\$6.10 *
CG-2001-07	22.2 x 9.52	7/8 x 3/8	1	\$7.80 *
CG-2001-08	25.4 x 7.93	1 x 5/16	1	\$6.25 *
CG-2001-09	25.4 x 9.52	1 x 3/8	1	\$7.60 *
CG-2001-10	28.6 x 7.93	1 1/8 x 5/16	1	\$6.50 *
CG-2001-11	34.9 x 9.52	1 3/8 x 3/8	1	\$9.20 *
CG-2001-12	38.1 x 7.93	1 1/2 x 5/16	1	\$6.90 *
CG-2001-13	38.1 x 9.52	1 1/2 x 3/8	1	\$9.20 *
CG-2001-15	41.3 x 7.93	1 5/8 x 5/16	1	\$8.45 *
CG-2001-17	50.8 x 9.52	2 x 3/8	1	\$11.95 *
CG-2001-18	63.5 x 7.93	2 1/2 x 5/16	1	\$13.55 *
CG-2001-19	63.5 x 9.52	2 1/2 x 3/8	1	\$14.00 *
CG-2001-20	76.2 x 12.7	3 x 1/2	1	\$25.30 *
CG-2001-50	Stir Bar Kit	—	1	\$181.50

## PTFE Magnetic Stir Bars, Plain

Similar action to cylindrical stir bars but gives more turbulence at low speed.

### Individual, PTFE, Magnetic Stir Bars

Part No.	Length x Dia. (mm)	Qty.	Price
CG-2001P-01	10 x 6	1	\$2.20 *
CG-2001P-02	15 x 6	1	\$2.40 *
CG-2001P-03	20 x 6	1	\$2.90 *
CG-2001P-04	25 x 6	1	\$3.05 *
CG-2001P-05	30 x 6	1	\$3.60 *
CG-2001P-06	40 x 8	1	\$4.35 *
CG-2001P-07	50 x 8	1	\$7.25 *
CG-2001P-08	60 x 10	1	\$8.50 *
CG-2001P-09	70 x 10	1	\$10.15 *
CG-2001P-10	80 x 10	1	\$11.20 *



CG-2001P-series

\* Lab Supply Prod. Line ◇ Life Sciences Consumable Prod. Line

Single rolls!



**Labeling Tape for Glass and Plastic**

- Available in 3/4" and 1" wide rolls by 500" long on 1" cores
- Adheres to any dry surface and removes cleanly and easily
- Durable, water-proof, oil and acid-resistant
- Withstands temperatures from -23 to 121°C
- Use with permanent marker, pencil or pen

Choose your colors and sizes.		3/4" x 500" Roll	Everyday Low Price	1" x 500" Roll	Everyday Low Price
		Part Number		Part Number	
white		CG-4035-21	\$6.95 *	CG-4035-61	\$8.45 *
yellow		CG-4035-22	\$6.95 *	CG-4035-62	\$8.45 *
green		CG-4035-23	\$6.95 *	CG-4035-63	\$8.45 *
red		CG-4035-24	\$6.95 *	CG-4035-64	\$8.45 *
orange		CG-4035-25	\$6.95 *	CG-4035-65	\$8.45 *
blue		CG-4035-26	\$6.95 *	CG-4035-66	\$8.45 *
pink		CG-4035-27	\$6.95 *	CG-4035-67	\$8.45 *
tan		CG-4035-28	\$6.95 *	CG-4035-68	\$8.45 *
salmon		CG-4035-29	\$6.95 *	CG-4035-69	\$8.45 *
copper		CG-4035-30	\$6.95 *	CG-4035-70	\$8.45 *
rose		CG-4035-31	\$6.95 *	CG-4035-71	\$8.45 *
violet		CG-4035-32	\$6.95 *	CG-4035-72	\$8.45 *
lavender		CG-4035-33	\$6.95 *	CG-4035-73	\$8.45 *
gray		CG-4035-34	\$6.95 *	CG-4035-74	\$8.45 *
lime		CG-4035-35	\$6.95 *	CG-4035-75	\$8.45 *
aqua		CG-4035-36	\$6.95 *	CG-4035-76	\$8.45 *
chartreuse		CG-4035-37	\$6.95 *	CG-4035-77	\$8.45 *
gold		CG-4035-38	\$6.95 *	CG-4035-78	\$8.45 *
silver		CG-4035-39	\$6.95 *	CG-4035-79	\$8.45 *
magenta		CG-4035-40	\$6.95 *	CG-4035-80	\$8.45 *
dark red		CG-4035-41	\$6.95 *	—	— *
maroon		CG-4035-42	\$6.95 *	CG-4035-82	\$8.45 *
dark brown		CG-4035-43	\$6.95 *	CG-4035-83	\$8.45 *
dark blue		CG-4035-44	\$6.95 *	CG-4035-84	\$8.45 *
dark green		CG-4035-45	\$6.95 *	CG-4035-85	\$8.45 *
black		CG-4035-46	\$6.95 *	CG-4035-86	\$8.45 *
fluorescent red		CG-4035-47	\$6.95 *	CG-4035-87	\$8.45 *
fluorescent orange		CG-4035-48	\$6.95 *	CG-4035-88	\$8.45 *
fluorescent green		CG-4035-49	\$6.95 *	CG-4035-89	\$8.45 *
fluorescent chartreuse		CG-4035-50	\$6.95 *	CG-4035-90	\$8.45 *
fluorescent pink		CG-4035-51	\$6.95 *	CG-4035-91	\$8.45 *



**Looking for tape assortment packs?**

See the 14-roll Rainbow Packs on the next page.





CG-4035-R-series

### Labeling Tape Rainbow Packs, General Purpose

- Adheres to any dry surface yet removes cleanly and easily
- Durable, waterproof, oil and acid-resistant
- Withstands temperatures from -23 to 121°C
- Accepts permanent marker, pencil or pen
- 500-inch rolls, 3/4 or 1 inch wide

Labeling tape for glass or plastic. These 14-roll rainbow packs include two rolls each of seven colors (white, yellow, green, red, orange, blue and lavender), with the same size cores.

#### 14-Roll Rainbow Packs of Labeling Tape - Two Rolls Each of Seven Colors

Part No.	Size (in.)	Colors Included (2 rolls each)	Price
CG-4035-R075	3/4	white, yellow, green, red, orange, blue and lavender	\$113.70 *
CG-4035-R100	1	white, yellow, green, red, orange, blue and lavender	\$141.00 *



CG-4035-D50

### Tape Dispenser, Red Plastic

Plastic hand dispenser is easy to fill and offers convenient way to cut 3/4" or 1" labeling tape. Tape not included.

Part No.	Qty.	Price
CG-4035-D50	1	\$8.10 *



CG-4035-D10

### Multi-roll Tape Dispenser with Suction Cup Feet, White Metal

Metal dispenser is easy to fill and offers convenient access to tape from a central location. White metal dispensers will accommodate 3/4" or 1" tape. Dispenser has a 1" core for 500" rolls. Base has suction cup feet. Tape not included.

#### Multi-roll Tape Dispenser with Suction Cup Feet, White Metal

Part No.	Dimensions L x W x H (in)	Qty.	Price
CG-4035-D10	9.375 x 5.125 x 2.75	1	\$92.90 *

### Multi-roll Tape Dispenser, White Metal

Metal dispenser is easy to fill and offers convenient access to tape from a central location. White metal dispensers will accommodate 3/4" or 1" tape. Dispenser has a 1" core for 500" rolls. Dimensions: 12"L x 5"W x 3.5"H. Tape not included.

#### Multi-roll Tape Dispenser, White Metal

Part No.	Dimensions L x W x H (in)	Qty.	Price
CG-4035-D12	12 x 5 x 3.5	1	\$62.00 *



CG-4035-D12

\* Lab Supply Prod. Line ◇ Life Sciences Consumable Prod. Line

## Economy Fluid Aspirator System

- Built-in pump quickly aspirates fluids while maintaining a low noise level (76db at 1 meter) and minimal vibration
- Chemical and corrosion resistant polypropylene collection bottle holds 3800mL (1 gallon) of fluid wastes and has a safety release vent to prevent vacuum implosion
- A replaceable hydrophobic filter seals itself if it becomes wet, protecting the pump motor from fluid contamination

Perform vacuum aspiration of a variety of liquids, including tissue culture media, supernatants and chemical wastes. Compact design will not crowd workspace. To use, simply insert a pipette tip, Pasteur pipette, or serological pipette into the collection tube and plug in to a 110 / 120V outlet. Self-contained system with bottle, tubing and vacuum pump is lightweight, compact and easy to use.

Part No.	Cap. (mL)	Bottle	Qty.	Price
CLS-910-100	3800 (1 gallon)	polypropylene	1	\$817.65 *

**Ideal for fluid collection in tissue and / or cell culture**



CLS-910-100

## BVC Fluid Aspirator Systems for Cell Culture

- Reliable VACUUBRAND vacuum pump used and proven in chemistry
- Suitable for two users with optional extension and hand controller
- 0.2 micron bio-filter helps protect pump and lab atmosphere
- Professional models have contact-free, external level sensors

Aspirator systems that accommodate your decontamination protocol whether you autoclave or disinfect in the bottle.

**Basic Models** are unpowered aspirator systems, suitable for use with in-house vacuum systems. A mechanical regulator provides a suitable vacuum level in the bottle for aspiration, and disconnects it from the supply when that level is reached- no power required. This reduces demand on the vacuum supply, increasing efficiency while reducing noise and impact on other applications. Unit is shipped ready for use and is supplied with a stable and easy-to-clean, powder-coated metal stand, 0.2um bio-filter, and hand controller.

**Control Models** feature a powerful, whisper-quiet Vacuubrand vacuum pump, eliminating the need for a central vacuum supply. When using the hand controller, the pump is turned on and off automatically. Suction power is electronically adjustable via the easy-clean touch panel.

**Professional Models** include an external liquid level sensor that does not contact the contents of the bottle, allowing you to work without worrying about overflow. A special disinfection program allows the aspiration of disinfectant after the system is shut down to decontaminate the hand control. The 4 liter polypropylene bottle version is supplied with quick connectors as standard; the 2 liter glass bottle version is supplied with barbed connections.

### BVC Fluid Aspirators

Part No.	Model	Cap. (L)	Bottle	Qty.	Price
CLS-900-100	Basic	4	polypropylene	1	\$1,420.00 *
CLS-900-105	Basic	2	glass	1	\$1,560.00 *
CLS-900-200	Control	4	polypropylene	1	\$2,880.00 *
CLS-900-205	Control	2	glass	1	\$3,030.00 *
CLS-900-300	Professional	4	polypropylene	1	\$3,510.00 *
CLS-900-305	Professional	2	glass	1	\$3,510.00 *



CLS-900-100  
BASIC  
Polypropylene



CLS-900-200  
CONTROL  
Polypropylene

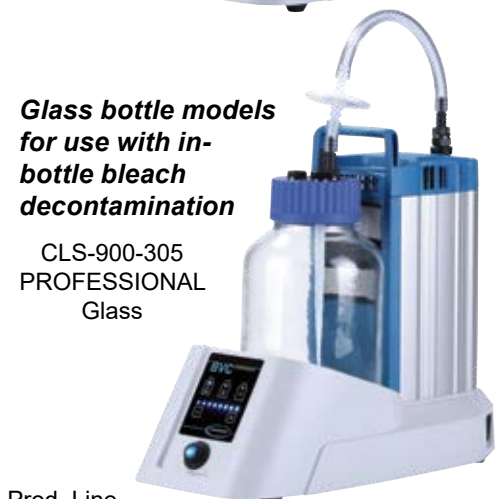

**Glass bottle models for use with in-bottle bleach decontamination**

CLS-900-305  
PROFESSIONAL  
Glass

† Reusable Glass / Plastics Prod. Line ♣ Consumable Prod. Line Ω EDU / Economical Pkg. Prod. Line

## AccuPet Pro, Variable Micropipettes, Single Channel, Air Displacement, Research Grade

AccuPet Pro micropipettes are the standard for microliter measurements. This line of digital pipettes is ergonomically designed and continuously adjustable. The AccuPet Pro is crafted to incorporate attractive form with practical function at an affordable price. Updated features allow for more comfortable pipetting and produce more precise results.

**Note:** Accuracy and precision value given at maximum volume of pipettor. No Tip Ejector on the CLS-3489E-09.

### AccuPet Pro Micropipettes

Part No.	Capacity Range (µL)	Qty.	Price
CLS-3489E-01	0.1-2.5	1	\$202.95 ◇
CLS-3489E-02	0.5-10	1	\$202.95 ◇
CLS-3489E-03	2-20	1	\$202.95 ◇
CLS-3489E-04	5-50	1	\$202.95 ◇
CLS-3489E-05	10-100	1	\$202.95 ◇
CLS-3489E-06	20-200	1	\$202.95 ◇
CLS-3489E-07	100-1000	1	\$202.95 ◇
CLS-3489E-08	500-5000	1	\$202.95 ◇
CLS-3489E-09	500-10,000	1	\$202.95 ◇

SuperLite ergonomic handle with rubber grip

DirectVue, easy-view, volume indicator

autoclavable lower portion

universal tip fitting shafts

tip ejector

Buy Two Get Third FREE\*

\*Participation in this offer is restricted to purchases at list price of CLS-3489E-series micropipettes. Mixing of sizes is permitted. Offer valid 1/1/2024 through 12/31/2024. Must specify promo code **ACCUPET24** when placing the order.

Valid on US and Canadian purchases only. May not be combined with any other offer or discount. Non-transferable and void where prohibited by law or company policy. Subject to Chemglass Life Sciences' standard terms, conditions and contracts. **Not valid through distributors.**

## CELLTREAT, Single Channel, Adjustable Volume Pipettes

- High precision adjustable pipette with easy-to-read volume display
- Continuously adjustable with locking ring to prevent volume changes while pipetting
- Lightweight design and easy operation with either hand
- Reduced operating forces; plunger is easy to press and dispense
- Stainless steel and PTFE components for long life; it is not recommended to autoclave more than 6 times
- Fits CELLTREAT Scientific Products Universal Pipette Tips for accurate pipetting

### CELLTREAT, Single Channel, Adjustable Volume Pipettes

Part No.	Capacity Range (µL)	Qty.	Price	SALE Price
CLS-3489C-01	1-10µL	1	<del>\$232.00</del>	\$185.60 ♣
CLS-3489C-02	2-20µL	1	<del>\$232.00</del>	\$185.60 ♣
CLS-3489C-03	20-200µL	1	<del>\$232.00</del>	\$185.60 ♣
CLS-3489C-04	30-300µL	1	<del>\$232.00</del>	\$185.60 ♣
CLS-3489C-05	100-1000µL	1	<del>\$232.00</del>	\$185.60 ♣

\* Lab Supply Prod. Line ◇ Life Sciences Consumable Prod. Line



## Disposable Reagent Reservoirs

Reservoirs designed for use in multichannel pipetting applications. Accommodate all types of pipettors up to 12-channel width. Feature a trough design, graduation marks on interior walls, and pour-off spouts on each corner. All sterile reservoirs are lot-certified, nonpyrogenic, and DNase- and RNase-free.

25mL reservoirs are available in a divided format that has either two or three distinct mini reservoir chambers. Two channel reservoirs have 5 and 10mL capacities. Three channel one has 5mL capacity each. All sizes made from virgin modified polystyrene. Available non-sterile or electron beam sterilized.

### Disposable Reagent Reservoirs - ALL ARE QUANTITIES OF 100 RESERVOIRS

Description	Individually Wrapped Sterile		Bulk Packed Non-sterile	
	Part No.	Price	Part No.	Price
25mL	<b>CLS-3798-001</b>	\$122.30 ◇	<b>CLS-3798-007</b>	\$74.75 ◇
50mL	<b>CLS-3798-003</b>	\$125.85 ◇	<b>CLS-3798-009</b>	\$89.60 ◇
100mL	<b>CLS-3798-005</b>	\$125.85 ◇	<b>CLS-3798-011</b>	\$89.60 ◇
1-Channel 25mL, *2-Channel 5mL/10mL	<b>CLS-3798-013</b>	\$138.65	<b>CLS-3798-015</b>	\$74.75 ◇
3-Channel, Divided 25mL,*3-Channel 5mL	<b>CLS-3798-017</b>	\$130.70 ◇	<b>CLS-3798-019</b>	\$68.80 ◇



CLS-3798-series

## Microplate Reservoir Trays, Virgin Polypropylene, PORVAIR

- Robot friendly and chemical- and heat-resistant
- Autoclavable and can be gamma irradiated
- Molded in natural virgin PP to ANSI / SLAS standard dimensions

Reservoir trays with spaces for single liquid or multiple liquids. Designed for use with any robotic liquid handling system. Most working configurations are accounted for as well as varying liquid volumes. Pyramid bottoms for very low dead volume.

### Microplate Reservoir Trays, Polypropylene, PORVAIR

Part No.	Description	Qty.	Price	SALE Price
<b>CLS-3590-085</b>	85mL, Low Profile, Flat Bottom	25	<del>\$335.50</del>	<b>\$268.40 ♣</b>
<b>CLS-3590-384</b>	384 Well, 2 Control Wells, Pyramid Bottom	25	<del>\$357.50</del>	<b>\$286.00 ♣</b>
<b>CLS-3590-024</b>	24 Column, Each 3.5mL, Low Profile, Partitioned, Pyramid Bottom	25	<del>\$335.50</del>	<b>\$268.40 ♣</b>



CLS-3590-384

CLS-3590-085

CLS-3590-024

Additional trays are available for a wide range of liquid handling configurations from 8 or 12 channel pipettes through to 96 or 384 pipette head.

## 5mL Reagent Reservoirs for 8-Channel Pipettes, Sterile

Our new ASPIR-8™ is the ideal reservoir for any lab utilizing 8-channel pipettes. The strict inner dimensions are designed specifically for 8 channels, thus conserving space and reagent over its longer 12-channel counterparts. This thinner design minimizes reagent exposure and usage. ASPIR-8™ is the only reservoir that is tailor-made for your 8-channel instrument.

### 5 mL, Eight-Channel Pipette Reservoirs, Sterile

Part No.	Description	Case Qty.	Price
<b>CLS-3799-001</b>	Individually Wrapped	100	<b>\$111.30 ◇</b>
<b>CLS-3799-005</b>	5 / Bag	200	<b>\$111.30 ◇</b>



CLS-3799

† Reusable Glass / Plastics Prod. Line ♣ Consumable Prod. Line Ω EDU / Economical Pkg. Prod. Line

1000 and 1250 $\mu$ L TipsCLS-3499C  
CLS-3499D

### Sterile Pipette Tips 1000 and 1250 $\mu$ L with Aerosol Barrier Filters

- Certified RNase, DNase, Human DNA, Pyrogen-Free
- Low-Retention, Fine-Point design for lowest sample adhesion
- Ultra-Clear polymer withstands organic solvents and provides clear, error-free pipetting
- Effective hydrophobic aerosol barrier eliminates carry-over and pipettor contamination
- Gamma-irradiated Sterile and Graduated
- Universal-fit for most single and multichannel pipettors



NEST Aerosol Filter Pipet Tips are designed and manufactured using premium-grade 100% polypropylene for the most critical molecular biology liquid handling applications. All Nest Aerosol Filter Tips are gamma irradiated Sterile and Certified RNase/DNase-Free, human DNA-Free, and Pyrogen-Free. In addition, Nest Aerosol Filter Tips are Ultra-Clear with a Fine-Point design for the convenient, precise pipetting of precious nucleic acid and protein samples and are designed to be Universal-fit for the majority of research-grade pipettors.

### Sterile Pipette Tips, 1000 and 1250 $\mu$ L with Aerosol Barrier Filters

Part No.	Size ( $\mu$ L)	Qty.	Reg. Price	SALE Price
CLS-3499C-1XL	1000	960	<del>\$94.50</del>	\$75.60 ♣
CLS-3499D-1XL	1000	4800	<del>\$472.00</del>	\$377.60 ♣
CLS-3499C-1250	1250, Standard	960	<del>\$94.50</del>	\$75.60 ♣
CLS-3499D-1250	1250, Standard	4800	<del>\$472.00</del>	\$377.60 ♣

See our complete line of liquid handling products on the web:

[www.cglifesciences.com](http://www.cglifesciences.com)



CLS-3489-L10

### Pipette Stand, Linear

Sturdy, linear stand can hold up to six single channel or multi-channel pipettes.

#### Linear Stand

Part No.	Qty.	Price
CLS-3489-L10	1	\$60.00 *

\* Lab Supply Prod. Line ◊ Life Sciences Consumable Prod. Line

## Sterile Pipette Tips with Aerosol Barrier Filters

- Certified RNase, DNase, Human DNA, Pyrogen-Free
- Low-Retention, Fine-Point design for lowest sample adhesion
- Ultra-Clear polymer withstands organic solvents and provides clear, error-free pipetting
- Effective hydrophobic aerosol barrier eliminates carry-over and pipettor contamination
- Gamma-irradiated Sterile and Graduated
- Universal-fit for most single and multichannel pipettors

NEST Aerosol Filter Pipet Tips are designed and manufactured using premium-grade 100% polypropylene for the most critical molecular biology liquid handling applications. All Nest Aerosol Filter Tips are gamma irradiated Sterile and Certified RNase/DNase-Free, human DNA-Free, and Pyrogen-Free. In addition, Nest Aerosol Filter Tips are Ultra-Clear with a Fine-Point design for the convenient, precise pipetting of precious nucleic acid and protein samples and are designed to be Universal-fit for the majority of research-grade pipettors.



CLS-3499C  
CLS-3499D

## Sterile Pipette Tips with Aerosol Barrier Filters

Part No.	Size (µL)	Length	Qty.	Reg. Price	SALE Price
CLS-3499C-010	10	Extra Long	960	<del>\$75.50</del>	\$60.40 ♣
CLS-3499D-010	10	Extra Long	4800	<del>\$377.50</del>	\$302.00 ♣
CLS-3499C-018	10	Standard	960	<del>\$75.50</del>	\$60.40 ♣
CLS-3499D-018	10	Standard	4800	<del>\$377.50</del>	\$302.00 ♣
CLS-3499C-020	20	Standard	960	<del>\$75.50</del>	\$60.40 ♣
CLS-3499D-020	20	Standard	4800	<del>\$377.50</del>	\$302.00 ♣
CLS-3499C-100	100	Standard	960	<del>\$75.50</del>	\$60.40 ♣
CLS-3499D-100	100	Standard	4800	<del>\$377.50</del>	\$302.00 ♣
CLS-3499C-200	200	Standard	960	<del>\$75.50</del>	\$60.40 ♣
CLS-3499D-200	200	Standard	4800	<del>\$377.50</del>	\$302.00 ♣
CLS-3499C-300	300	Standard	960	<del>\$76.50</del>	\$61.20 ♣
CLS-3499D-300	300	Standard	4800	<del>\$382.50</del>	\$306.00 ♣



## Pipette Stand, Carousel

Carousel pipettor stand can be rotated smoothly and hold up to 6 single channel or multi-channel pipettes.

### Carousel Stand

Part No.	Description	Qty.	Price
CLS-3489-R10	Pipette Stand, Carousel	1	\$70.00 *

CLS-3489-R10



† Reusable Glass / Plastics Prod. Line ♣ Consumable Prod. Line Ω EDU / Economical Pkg. Prod. Line

### Transferpette® S Eight-Channel Pipettes, BRAND®

Transferpette S Multichannel pipettes are supplied with performance certificate, operating manual, shelf mount, reagent reservoir, pack of replacement v-rings, and one year warranty.

#### Transferpette® S Eight-Channel Pipettes

Part No.	Capacity Range (µL)	Color Code	Qty.	Price
CLS-3491-B01	0.5-10	grey	1	\$906.00 ◇
CLS-3491-B02	5-50	yellow	1	\$906.00 ◇
CLS-3491-B03	10-100	yellow	1	\$906.00 ◇
CLS-3491-B04	20-200	yellow	1	\$906.00 ◇
CLS-3491-B05	30-300	green	1	\$906.00 ◇

### Transferpette® S Single Channel, Fixed Volume Pipettes, BRAND®

Transferpette S Single Channel pipettes are supplied with performance certificate, operating manual, shelf mount, and three-year warranty.

- Slim hand grip — Provides a comfortable and secure fit in any hand
- One-handed operation — Perform all functions (set volume, pipette, tip ejection) without changing your grip
- Volume-change protection — Simple to operate and clearly shows when the volume setting is locked
- Slim shaft — Narrow tubes? With the slim shaft, easily pipette into narrow tubes such as 15 mL conical tubes
- Easy cleaning — The shaft tucks inside the handgrip for smooth surfaces, making cleaning easier
- Low forces — Short pipetting stroke, easy mounting and tip ejection make pipetting a breeze
- Universal tip cone fits tips from most quality manufacturers
- Completely autoclavable at 121 °C
- Color-coded pipette accents make pipette and tip selection easy

#### Transferpette® Single Channel, Fixed Volume Pipettes

Part No.	Capacity (µL)	Color Code	Qty.	Price
CLS-3490-F01	10	grey	1	\$213.00 ◇
CLS-3490-F02	20	yellow	1	\$213.00 ◇
CLS-3490-F03	25	yellow	1	\$213.00 ◇
CLS-3490-F04	50	yellow	1	\$213.00 ◇
CLS-3490-F05	100	yellow	1	\$213.00 ◇
CLS-3490-F06	200	yellow	1	\$213.00 ◇
CLS-3490-F07	500	navy	1	\$213.00 ◇
CLS-3490-F08	1,000	navy	1	\$213.00 ◇



CLS-3491-B-series



CLS-3490-F-series

\* Lab Supply Prod. Line ◇ Life Sciences Consumable Prod. Line

## Transferpette® S Single Channel, BRAND®

Transferpette S Single Channel pipettes are supplied with performance certificate, operating manual, shelf mount, and three-year warranty.

- Slim hand grip — Provides a comfortable and secure fit in any hand
- One-handed operation — Perform all functions (set volume, pipette, tip ejection) without changing your grip
- Volume-change protection — Simple to operate and clearly shows when the volume setting is locked
- Slim shaft — Narrow tubes? With the slim shaft, easily pipette into narrow tubes such as 15 mL conical tubes
- Easy cleaning — The shaft tucks inside the handgrip for smooth surfaces, making cleaning easier
- Low forces — Short pipetting stroke, easy mounting and tip ejection make pipetting a breeze
- Universal tip cone fits tips from most quality manufacturers
- Completely autoclavable at 121 °C
- Color-coded pipette accents make pipette and tip selection easy

### Transferpette® Single Channel, Pipettes

Part No.	Capacity (µL)	Color Code	Qty.	Price
CLS-3490-B01	0.1-1	grey	1	\$357.00 ◇
CLS-3490-B02	0.1-2.5	grey	1	\$357.00 ◇
CLS-3490-B03	0.5-10	grey	1	\$357.00 ◇
CLS-3490-B04	2-20	yellow	1	\$357.00 ◇
CLS-3490-B05	5-50	yellow	1	\$357.00 ◇
CLS-3490-B06	10-100	yellow	1	\$357.00 ◇
CLS-3490-B07	20-200	yellow	1	\$357.00 ◇
CLS-3490-B08	100-1,000	navy	1	\$357.00 ◇
CLS-3490-B09	500-5,000 (µL) / 0.5-5mL	red	1	\$357.00 ◇
CLS-3490-B10	1,000-10,000 (µL) / 1-10mL	blue	1	\$357.00 ◇



CLS-3490-B-series

CLS-3499-B01



CLS-3499-B02



CLS-3499-B03



CLS-3499-B04



### Standard Pipette Tips in Tip-Boxes, Bulk Bags or Sterile Tip-Boxes BRAND®

- High-purity polypropylene, free from DiHEMDA and oleamide
- Manufactured without lubricants
- Cadmium-free pigments
- Rack-packed tips and filter tips up to 1000 µL free of DNA
- (<40 fg), RNase (<8.6 fg), endotoxins (<1 pg) and ATP (<1 fg)
- Autoclavable at 121 °C (2 bar), acc. DIN EN 285
- Environmentally friendly packaging systems
- CE-marked according to IVD-Directive 98/79 EC
- BIO-CERT® tips sterile per ISO 11137 and AAMI guidelines; a SAL of 10<sup>-6</sup> is obtained



#### Specifications

Cap, Range (µL)	Length (mm)	Grads. (µL)
0.1-20	37	—
0.5-20	46	2 & 10
2-200	50	20 & 100
5-300	53	50 & 100
50-1000	70	250, 500 & 1000
0.5-5 (mL)	160 (~9.6 Diam.)	—
1-10 (mL)	156.5 (~15 Diam.)	—

#### Standard Tips in Tip-Boxes

Part No.	Boxes x No. of Tips	Total Qty.	Price
CLS-3499-B01	5 x 96	480	\$35.60 *
CLS-3499-B02	5 x 96	480	\$14.00 *
CLS-3499-B03	5 x 96	480	\$14.00 *
—			
CLS-3499-B05	5 x 96	480	\$14.00 *
CLS-3499-B06	1 x 28	28	\$54.00 *
CLS-3499-B07	1 x 18	18	\$109.00 *

\* Lab Supply Prod. Line ◇ Life Sciences Consumable Prod. Line

CLS-3499-B05



CLS-3499-B06



CLS-3499-B07



All BRAND® pipette tips are produced using the most advanced cleanroom techniques to ensure consistently high quality. The tips are manufactured in an environmentally friendly manner using only high-purity polypropylene, free from oleamide and diHEMA - additives which can interfere with biological tests. Available non-sterile or BIO-CERT® sterile in a variety of packaging options. Tip volumes range from 0.1µL to 10mL.

BRAND pipette and filter tips are tested and designed to fit BRAND pipettes and most of the pipettes from GILSON®, Thermo Fisher Scientific FINNPIPETTE®, Eppendorf® and BIOHIT® / Sartorius®. The 5mL tip is exclusively tested for BRAND pipettes and Thermo Fisher Scientific FINNPIPETTE®. The 10mL tip is suitable for BRAND and Eppendorf® pipettes.



#### Standard Tips in Bulk Packs

Part No.	Bags x No. of Tips	Total Qty.	Price
CLS-3499-BB1	2 x 1000	2000	\$119.00 *
CLS-3499-BB2	2 x 1000	2000	\$90.00 *
CLS-3499-BB3	1 x 1000	1000	\$24.20 *
CLS-3499-BB4	1 x 1000	1000	\$38.20 *
CLS-3499-BB5	2 x 500	1000	\$26.60 *
CLS-3499-BB6	1 x 200	200	\$53.00 *
CLS-3499-BB7	2 x 100	200	\$103.00 *

#### Standard Tips in Tip-Boxes, STERILE

Part No.	Boxes x No. of Tips	Total Qty.	Price
—			
CLS-3499-BS2	10 x 96	960	\$28.80 *
CLS-3499-BS3	10 x 96	960	\$28.80 *
CLS-3499-BS4	10 x 96	960	\$28.80 *
CLS-3499-BS5	10 x 96	960	\$28.80 *
—			
—			



CLS-3473-series

### CAPP® Tempo Pipette Controllers

- **Digital Display:** Shows battery status and aspiration / dispensing speed. Flashes when battery is low and turns off after 20 seconds of non-use.
- **Powerful Motor:** 0 to 25mLs in under 12 seconds. Six different speed settings.
- **EBS – Electronic Break System:** Maximizes speed and precision. Pipette maximum speed and press the EBS to slow down at the last second. Press EBS a second time to return to maximum speed.
- **Aspiration and Dispensing:** Separate speeds for each mode.

The CAPP Tempo Pipette Controller has revolutionary features that separate it from other controllers. Problems of over pipetting and having limited features with your old pipette controllers are gone. The proprietary Electronic Break System (EBS) allows users to pipette at maximum speed without compromising accuracy. The controller allows you to fill 25mL in less than 12 seconds and provides six different speed settings for both aspiration and dispense modes. Additionally, the CAPP Tempo comes with an LED display so you always know the aspiration speed, dispense speed and battery life.

#### CAPP Tempo Pipette Controller

Part No.	Volume Range (mL)	Color	Qty.	Price
CLS-3473-BLU	0.1-100	blue	1	\$394.60 ◇
CLS-3473-GRE	0.1-100	green	1	\$394.60 ◇
CLS-3473-RED	0.1-100	red	1	\$394.60 ◇



CLS-3472-10

### CHEMcell™, Motorized Pipette Filler

The motorized pipette filler features a full volume range of 0.1 to 100mL with easy one-handed operation. Its lightweight, ergonomic design allows longer, fatigue-free pipetting with separate aspirate and dispense speed controls. A large LCD display provides visual confirmation of remaining battery charge and speed settings. The lithium-ion battery offers long runtimes per charge without battery memory problems. The fully autoclavable nosecone housing simplifies disinfecting and decontamination.

#### Motorized Pipette Filler

Part No.	Volume Range (mL)	Qty.	Price
CLS-3472-10	0.1-100	1	\$388.10 ◇

#### Replacement Parts

Part No.	Description	Qty.	Price
CLS-3472-12	0.45µm Hydrophobic Filter	1	\$11.55 ◇
CLS-3472-14	0.20µm Sterile Hydrophobic Filter	1	\$9.20 ◇
CLS-3472-18	Standard Nose	1	\$28.90 ◇
CLS-3472-20	Silicone Adapter	1	\$9.25 ◇

\* Lab Supply Prod. Line ◇ Life Sciences Consumable Prod. Line



## Sterile, Color-coded, Individually Wrapped, Serological Pipettes, NEST

- Edged color-coded band for identification
- Include negative graduations for extra volume
- Non-pyrogenic, non-cytotoxic, non-hemolytic, DNase- and RNase-free
- Polyolefin fiber filter to reduce contamination
- Made from high clarity polystyrene
- Sterilized by E-beam

Serological pipettes are made of super clear clarity polystyrene (PS). Serological pipettes are designed to be used in both tissue culture and bacterial culture experiments, and other liquid handling applications.

### Sterile, Color-coded, Individually Wrapped, Serological Pipettes

Part No.	Cap. (mL)	Color	Qty.	Price	SALE Price
CGN-3481-001	1	yellow	500	<del>\$81.50</del>	\$65.20 ♣
CGN-3481-002	2	green	400	<del>\$70.50</del>	\$56.40 ♣
CGN-3481-005	5	blue	200	<del>\$52.00</del>	\$41.60 ♣
CGN-3481-010	10	orange	200	<del>\$58.00</del>	\$46.40 ♣
CGN-3481-025	25	red	200	<del>\$94.50</del>	\$75.60 ♣
CGN-3481-050	50	black	100	<del>\$88.50</del>	\$70.80 ♣



CGN-3481-series



### Magnetized Pipette Storage Rack

Magnetized pipette storage rack with strong magnets on both sides to mount securely on fume hoods, file cabinets, refrigerators, etc. Made of durable ABS plastic, this rack looks better and will hold up better than acrylic. Includes two handy attachments for holding pipette bulbs, pipette fillers and pipette pumps.

### Magnetized Pipette Storage Rack

Part No.	L x W x H (mm)	Qty.	Price
CLS-3476-01	290 x 85 x 395	1	\$98.00 ◇

CLS-3476-01

**Non-Graduated Transfer Pipets****Disposable Transfer Pipets, Bulk Packed, Non-Sterile**

Unbreakable, all-in-one pipets eliminate the hazards of broken glass and exposure to infectious materials. Put an end to matching rubber bulbs and glass pipets. Molded from transparent, low density polyethylene; inert to biological fluids and most acids. The low-affinity surface reduces the loss of cells and valuable proteins due to binding. Can be sealed and refrigerated. Temperature resistant from  $-196^{\circ}$  to  $+90^{\circ}\text{C}$ . Can be used in liquid nitrogen.

**Disposable Transfer Pipets in Bulk Packs, Non-Graduated, Non-Sterile**

Part No.	Cap. (mL)	Length (cm)	Graduations	Qty.	Price
<b>CLS-3485-001</b>	1.2	—	non-graduated	500	<b>\$27.60</b> ◇
<b>CLS-3485-007</b>	1.7	—	non-graduated	500	<b>\$27.60</b> ◇
<b>CLS-3485-013</b>	4.0	—	non-graduated	500	<b>\$29.40</b> ◇
<b>CLS-3485-034</b>	6.0	—	non-graduated	500	<b>\$39.40</b> ◇
<b>CLS-3485-044</b>	8.0	—	non-graduated	400	<b>\$36.20</b> ◇

**Disposable Transfer Pipets in Bulk Packs, Graduated, Non-Sterile**

Part No.	Cap. (mL)	Length (cm)	Graduations	Qty.	Price
<b>CLS-3485-004</b>	1.5	—	graduated	500	<b>\$28.60</b> ◇
<b>CLS-3485-010</b>	3.0	—	graduated	500	<b>\$29.40</b> ◇
<b>CLS-3485-018</b>	5.0	15	graduated	500	<b>\$30.65</b> ◇
<b>CLS-3485-023</b>	5.0	15.5	graduated	500	<b>\$29.05</b> ◇
<b>CLS-3485-028</b>	5.0	15.6	graduated	500	<b>\$29.40</b> ◇
<b>CLS-3485-039</b>	7.0	—	graduated	500	<b>\$30.70</b> ◇

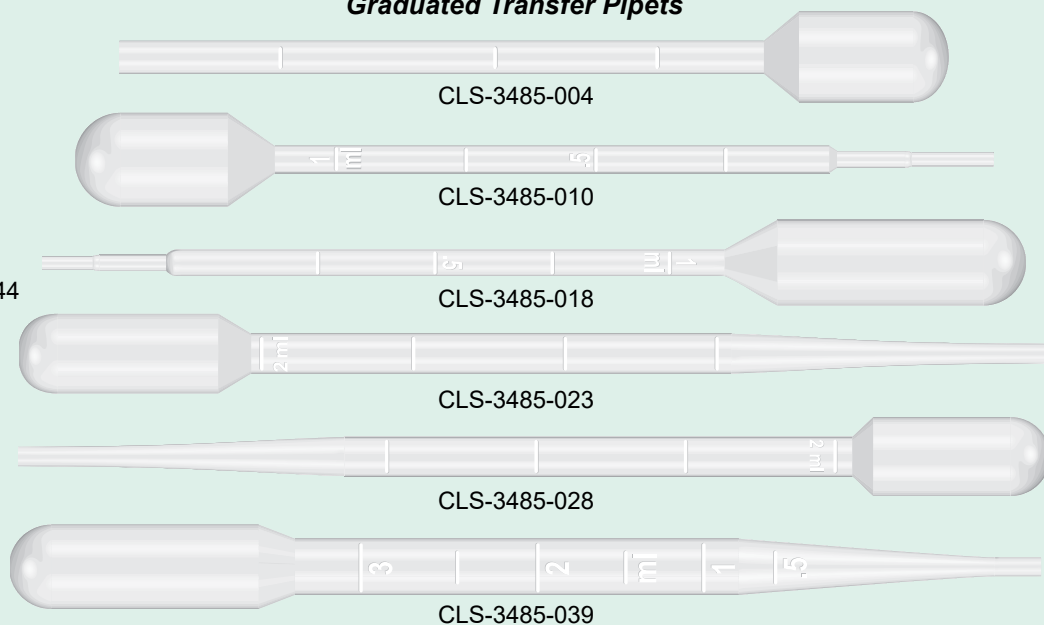
**Graduated Transfer Pipets**

\* Lab Supply Prod. Line ◇ Life Sciences Consumable Prod. Line

### Non-Treated Petri Dishes, Sterile, NEST

- High clarity polystyrene
- Flat, transparent surface
- Stackable for easy storage and handling
- Non-treated
- Sterilized by E-Beam
- Non-pyrogenic

These non-treated polystyrene plates are transparent and DNase/RNase-free. The bottom has a ridge allowing for easy handling and stacking. The plate has three vents for gas exchange.



CGN-1802-series

### Non-Treated Petri Dishes, NEST, Sterile

Part No.	Dia. x Height (mm)	Pack Qty.	Qty.	Price	SALE Price
CGN-1802-035	35 x 12	20	500	<del>\$115.50</del>	\$92.40 ♣
CGN-1802-060	60 x 15	20	500	<del>\$120.50</del>	\$96.40 ♣
CGN-1802-145	150 x 15	10	100	<del>\$186.00</del>	\$148.80 ♣

### Non-Treated Petri Dishes, Sterile, 100mm, Economy

- High clarity polystyrene
- Flat, transparent surface
- Stackable for easy storage and handling
- Sterilized by E-Beam
- Non-pyrogenic, DNase- and RNase-free
- Packaged 20 / sleeve, 500 / case

These non-treated polystyrene plates are transparent and DNase / RNase-Free. The bottom has a ridge allowing for easy handling and stacking. The plate has three vents for gas exchange.



CGE-1802-102

### Non-Treated, Economy Petri Dishes, Sterile

Part No.	Dia. x Height (mm)	Pkg. Type	Qty.	Price
CLS-1802-100	100 x 15	case	500	\$141.00 ◇
CGE-1802-102	100 x 15	sleeve	20	\$12.00 Ω

### Cell Spreaders, Glass

Made of 5mm borosilicate glass, spreaders are ideal for spreading inoculums over the agar face in Petri dish cultures. Available in two styles, 90° bend and 120° bend.

#### Glass Cell Spreaders

Part No.	Material	Bend	Qty.	Price
CLS-1350-01	borosilicate glass	120°	10	\$124.60 ◇
CLS-1350-02	borosilicate glass	90°	10	\$46.70 ◇



CLS-1350-01



CLS-1350-02

† Reusable Glass / Plastics Prod. Line ♣ Consumable Prod. Line Ω EDU / Economical Pkg. Prod. Line

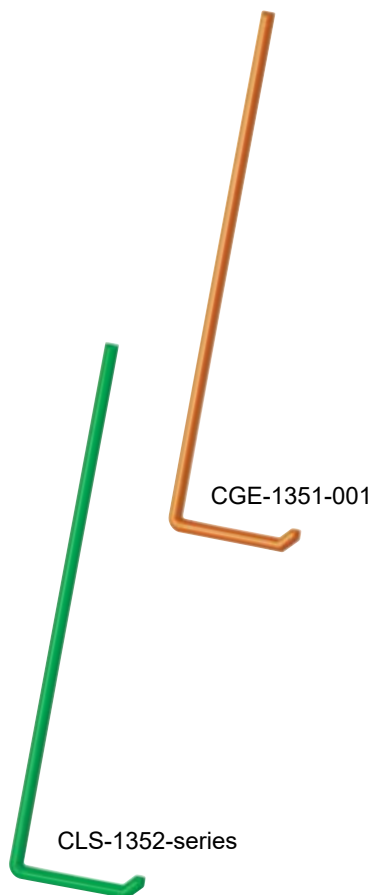

### Cell Spreaders, Polystyrene, Sterile

- L-shaped spreaders made of polystyrene
- Smooth surface and angled end reduce risk of damaging culture medium
- L-shape allows application on the entire culture dish or plate surface
- 10 per bag (sterile, resealable)
- Gamma radiation sterilized

#### Polystyrene Cell Spreaders, L-shaped, Sterile

Part No.	Material	Color	Qty.	Price
CGE-1351-001	polystyrene	orange	10	\$4.60 Ω

### L-Shaped Cell Spreaders, Polypropylene, Sterile

- Unlike glass spreaders, durable polypropylene L-shaped cell spreaders are non-breakable and pose no safety hazard
- L-Shaped for convenient spreading; just turn the Petri dish for smooth, even sample distribution
- Smooth spreading surface and a slight upward turn reduce the chance that the spreader will dig into agar
- Packaged sterile (gamma irradiated) in individual or bulk, easy-to-open, paper / plastic wrappers
- Pre-sterilization eliminates flaming or autoclaving and reduces risk of contamination

L-shaped cell spreaders are disposable, microbiological spreaders that provide an economical alternative to bending glass rods or pipettes for spreading samples on agar surfaces and filters in Petri dishes.

#### Polypropylene, Cell Spreaders, L-Shaped, Sterile

Part No.	Packaging	Color	Qty.	Price	SALE Price
CLS-1352-C01	Individually Wrapped	green	100	<del>\$67.00</del>	\$53.60 ♣
CLS-1352-C02	Bulk Packed, 10 / Pack	green	500	<del>\$129.00</del>	\$103.20 ♣



### Inoculating Loops and Needles, Polypropylene, Sterile

Loops and needles are made from high quality polypropylene and are flexible so stem can be bent to access small volume tubes and dishes. Color coded for easy identification. Vacuum-gas plasma surface treated. Packaged in peel-to-open paper plastic wrappers. Product is sterile (gamma irradiated).

#### Inoculating Loops and Needles, Polypropylene, Sterile

Part No.	Description	Color	Qty.	Price
CGE-2458-010	Loop, 10uL	blue	20	\$6.00 Ω
CGE-2458-015	Needle	yellow	20	\$6.00 Ω

\* Lab Supply Prod. Line ♠ Life Sciences Consumable Prod. Line

## Inoculation Picks, SMARTPICKS

- Go from autoclave to microtube
- Available in three lengths and with semi or needle points
- Non-sterile, meet FDA requirements for food
- 100% USA grown white birch
- Environmentally friendly – naturally biodegradable

Wooden inoculation picks provide a faster way to inoculate. It's simple, after autoclaving, just "pick" the colony, drop the wooden pick into your media and close the lid. No need to remove the pick. Available in three convenient sizes to accommodate various transfer, inoculation and streaking needs. Made in a USA, ISO and FDA registered facility.

### Inoculation Picks, SMARTPICKS

Part No.	Size	Point Type	OD x Length (mm)	Qty.	Price
<b>CLS-3670-100</b>	Mini	Semi	0.254 x 3.25 (Fits 1.5mL Tubes)	2000	<b>\$77.10</b> *
<b>CLS-3670-102</b>	Mini	Needle	0.254 x 3.25 (Fits 1.5mL Tubes)	2000	<b>\$77.10</b> *
<b>CLS-3670-104</b>	Standard	Semi	0.254 x 6.35	1600	<b>\$101.05</b> *
<b>CLS-3670-106</b>	Standard	Needle	0.254 x 6.35	1600	<b>\$101.05</b> *
<b>CLS-3670-108</b>	Large	Semi	0.3175 x 15.24	500	<b>\$57.80</b> *
<b>CLS-3670-110</b>	Large	Needle	0.3175 x 15.24	500	<b>\$56.10</b> *

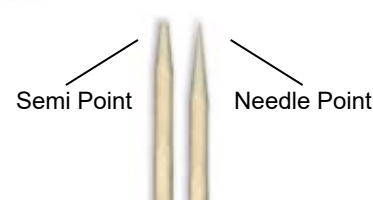

It's easy . . .



pick

drop

close

## White Glass Microscope Slides, 90° Ground Edge

- Packed in high-quality white plastic boxes

Diamond™ White Glass plain microscope slides are for use in non-sterile pathology and cytology applications. The slides are pre-cleaned and ready to use.

### White Glass, Microscope Slides

Part No.	Dimensions (mm)	Thickness (mm)	Qty.	Price
<b>CG-8225-75X25</b>	25 x 75	1	144	<b>\$34.05</b> †



CG-8225-75X25

## White Glass Microscope Slides, 90° Ground Edge

- Chemically etched frosting
- Packed in high-quality white plastic boxes

Diamond™ White Glass frosted microscope slides are produced using a unique chemical etching process. They are frosted one end and two sides. This provides our slides with a smooth frosted finish that won't wear out slide marking pens. The slides are pre-cleaned and ready to use.

### White Glass, Microscope Slides, Frosted One End and Two Sides

Part No.	Dimensions (mm)	Thickness (mm)	Qty.	Price
<b>CG-8984-01</b>	25 x 75	1	144	<b>\$38.50</b> †

Made from the finest quality optical white glass.



CG-8984-01

† Reusable Glass / Plastics Prod. Line ♣ Consumable Prod. Line Ω EDU / Economical Pkg. Prod. Line



CG-8217-01

*Made from the finest quality optical white glass.*

*Packed in white plastic boxes.*



CG-8219-01

## White Glass Microscope Slides, 90° Ground Edge

Ground edge microscope slides offer 90° corners and are perfect for use in automatic cover slip machines. Safety corners provide comfortable handling and prevent the risk of finger and hand cuts. Slides are printed with "Globe" under the frosting area for orientation purposes. They are pre-cleaned and ready to use. Produced from the finest quality white glass. Ideal for use in histology, cytology and pathology departments. Available in white, they are pre-cleaned and ready to use. Other colors available, contact [tech@cglifesciences.com](mailto:tech@cglifesciences.com) for more information.

### White Glass, Microscope Slides with Ground Edges

Part No.	Dimensions (mm)	Thickness (mm)	Qty.	Price
CG-8217-01	25 x 75	1.1	144	\$47.10 †

## White Frosted Glass Microscope Slides, 90° Corners

- Chemically etched frosting
- Other colors available

Diamond™ White Glass, frosted microscope slides are made using a unique chemical etching process that provides slides with a smooth frosted finish that won't wear out marking pens. Available with 90° corners and single-sided frosting. Pre-cleaned and ready to use.

### White Frosted Microscope Slides

Part No.	Dimensions (mm)	Thickness (mm)	Qty.	Price
CG-8219-01	25 x 75	1	144	\$41.05 †

## Cover Slips, #1 Float Glass

Cover slips are manufactured from Float Glass, #1 thickness (0.13 to 0.17mm).

### Square and Rectangular Cover Slips in One Ounce Packages, #1



CLS-1762-series

Part No.	Shape	Dimensions (mm)	Approx. No. / Oz.	Qty.	Price
CLS-1762-1818	square	18 x 18	242	1 Oz.	\$30.35 ◇
CLS-1762-2222	square	22 x 22	150	1 Oz.	\$30.35 ◇
CLS-1762-2525	square	25 x 25	125	1 Oz.	\$23.05 ◇
CLS-1762-0935	rectangular	9 x 35	260	1 Oz.	\$52.20 ◇
CLS-1762-0950	rectangular	9 x 50	175	1 Oz.	\$56.70 ◇
CLS-1762-1050	rectangular	10.5 x 50	150	1 Oz.	\$36.95 ◇
CLS-1762-1354	rectangular	13 x 54	120	1 Oz.	\$62.00 ◇
CLS-1762-2230	rectangular	22 x 30	119	1 Oz.	\$24.70 ◇
CLS-1762-2240	rectangular	22 x 40	89	1 Oz.	\$30.35 ◇
CLS-1762-2250	rectangular	22 x 50	71	1 Oz.	\$30.35 ◇
CLS-1762-2430	rectangular	24 x 30	109	1 Oz.	\$25.45 ◇
CLS-1762-2440	rectangular	24 x 40	82	1 Oz.	\$30.35 ◇
CLS-1762-2450	rectangular	24 x 50	65	1 Oz.	\$30.35 ◇
CLS-1762-2460	rectangular	24 x 60	54	1 Oz.	\$23.05 ◇
CLS-1762-2575	rectangular	25 x 75	40	1 Oz.	\$44.75 ◇

\* Lab Supply Prod. Line ◇ Life Sciences Consumable Prod. Line

## Round Cover Slips, #1, German Glass

Cover slips are manufactured from the highest quality, borosilicate, hydrolytic, class 1, German glass. They have excellent resistance to chemicals and are ideal for neural tissue culture and hard-to-attach cells. These cover slips are exceptional for fluorescence and confocal microscopy.

### Round Cover Slips in One Ounce Packages, #1

Part No.	Fits Well Plates	Diameter (mm)	Approx. No. / Oz.	Qty.	Price
CLS-1760-012	24	12	650	1 Oz.	\$98.85 ◇
CLS-1760-015	12	15	378	1 Oz.	\$86.35 ◇
CLS-1760-025	6	25	160	1 Oz.	\$52.40 ◇



CLS-1760-series

## Round Cover Slips, #1, CORNING 0211 Glass

Round cover slips are manufactured from Corning 0211 Float Glass, #1 thickness (0.13 to 0.16mm).

### Round Cover Slips in One Ounce Packages, #1

Part No.	Fits Well Plates	Diameter (mm)	Approx. No. / Oz.	Qty.	Price
CLS-1763-012	24	12	650	1 Oz.	\$143.50 ◇
CLS-1763-015	12	15	378	1 Oz.	\$86.90 ◇
CLS-1763-018	12	18	170	1 Oz.	\$112.95 ◇
CLS-1763-025	6	25	160	1 Oz.	\$68.55 ◇



CLS-1763-series

## Round Cover Slips, Glass, NEST

Cover Glass/Slips for Microscope Slides from NEST Scientific are made from high-quality glass that is non-cytotoxic. Suitable for use with 6-, 12- and 24-well cell culture plates.

- High-quality glass, non-cytotoxic
- Thickness: 0.16 - 0.19 mm
- Manufactured in 100,000 grade clean rooms
- Resistant to organic solvents
- Fully autoclavable
- Can be used in a confocal experiment
- Available in diameters of 14, 15, 18, 20 and 25mm

### Round Cover Slips, Glass

Part No.	Fits Well Plates	Diameter (mm)	Qty.	Price	SALE Price
CGN-1763-N14	24	14	100	<del>\$66.00</del>	\$52.80 ♣
CGN-1763-N15	24	15	100	<del>\$66.00</del>	\$52.80 ♣
CGN-1763-N18	12	18	100	<del>\$66.00</del>	\$52.80 ♣
CGN-1763-N20	12	20	100	<del>\$66.00</del>	\$52.80 ♣
CGN-1763-N25	6	25	100	<del>\$66.00</del>	\$52.80 ♣



CGN-1763-N-series

† Reusable Glass / Plastics Prod. Line ♣ Consumable Prod. Line Ω EDU / Economical Pkg. Prod. Line



CGN-3615-01N

### 96-Well PCR Plate, 0.2mL, No Skirt, Clear, H1 Notch, NEST

- Polypropylene
- Plate without skirt can be cut to any desired format
- Cut corner in position H1
- RNase-, DNase- and Pyrogen-free

The low profile design minimizes the condensate contamination and evaporation of reaction solution.

### 96-Well PCR Plate, No Skirt, Clear, H1 Notch

Part No.	Cap. (mL)	Qty.	Price	SALE Price
CGN-3615-01N	0.2	25	<del>\$87.00</del>	\$69.60 ♣



CGN-3617-series

### 0.2ML 96-Well PCR Plate, Semi-skirt, Clear, A12 Notch, NEST

- Polypropylene
- Plate without skirt can be cut to any desired format
- Cut corner in position A12
- RNase-, DNase- and Pyrogen-free

The low-profile design minimizes the condensate contamination and evaporation of reaction solution.

### 96-Well PCR Plate, Semi-Skirt, Clear, A12 Notch

Part No.	Equivalent	Cap. (mL)	Qty.	Price	SALE Price
CGN-3617-01	—	0.2	25	<del>\$62.50</del>	\$50.00 ♣
CGN-3617-02	ABI	0.2	25	<del>\$63.00</del>	\$50.40 ♣

### 8-Tube PCR Reaction Strips with Attached Flat Caps, 0.2mL

- Individually capped, extra-thin wall polypropylene tubes for optimal transfer and short cycle times
- Tight sealing, easy-open caps are angularly attached to tubes
- Flat, optically clear caps
- Supplied non-sterile in resealable bags
- Autoclavable



CLS-3611-V01

### 8-Tube PCR Strips with Attached Flat Caps

Part No.	Tube Cap. (mL)	Qty.	Price	SALE Price
CLS-3611-V01	0.2	120	<del>\$108.00</del>	\$78.80 ♣

\* Lab Supply Prod. Line ◇ Life Sciences Consumable Prod. Line



### Microcentrifuge Tubes with Lock Caps, Clear, NEST

- Available non-sterile and sterile
- USP VI grade polypropylene material, free from heavy metal
- RCF: 30,000 x g
- Endotoxin level: <0.1EU, DNase- and RNase-free
- Safe-lock cap design provides secure lid sealing; easy open / easy close
- Temperature range: -80° to +121°

Tubes are autoclavable at 121°C (250°F), under 15psi for 10–15 minutes with drying. Remove from autoclave immediately. Excessive exposure to autoclaving heat may cause warping or decreased structural integrity.

Part No.	Bottom Type	Capacity (mL)	Inner Bag Qty.	Pack Qty.	Price	SALE Price
<b>Non-Sterile, Micro Centrifuge Tubes with Lock Caps - 0.6mL</b>						
CGN-4300-06L	conical	0.6	—	1000	<del>\$25.00</del>	\$20.00 ♣
<b>STERILE Micro Centrifuge Tubes with Lock Caps - 0.6mL</b>						
CGN-4300-06N	conical	0.6	50	750	<del>\$26.00</del>	\$20.80 ♣
<b>STERILE Micro Centrifuge Tubes with Lock Caps - 1.5mL</b>						
CGN-4300-15N	conical	1.5	50	400	<del>\$19.50</del>	\$15.60 ♣
<b>Non-Sterile Micro Centrifuge Tubes with Lock Caps - 2.0mL</b>						
CGN-4310-020	round	2.0	—	500	<del>\$20.00</del>	\$16.00 ♣
<b>STERILE Micro Centrifuge Tubes with Lock Caps - 2.0mL</b>						
CGN-4310-02L	round	2.0	50	400	<del>\$20.00</del>	\$16.00 ♣

### Microcentrifuge Tubes, 1.5mL, Assorted Colors, Sterile

- Polypropylene tubes in blue, red, green, yellow and purple
- Tested up to 28,000xg
- Usable temperature range: -90°C to +121°C
- Sterile, RNase-, DNase- and pyrogen-free

SureSeal S™ microcentrifuge tubes are designed for a broad range of research applications, including enzyme digests, DNA isolation/purification, centrifugation, incubation, and general sample / reagent storage.

Manufactured under clean room conditions, using only BioClear™ co-polymer, an advanced polypropylene that maximizes clarity, centrifugal strength (tested up to 28,000xg) and the usable temperature range (-90°C to +121°C).

The oversized tube cap (with frosted marking surface), combined with the unique ring & groove closure, enhances the security of the liquid-tight seal, while minimizing the required locking forces for a more ergonomic opening / closing of the tube caps. All SureSeal S™ tubes are RNase-, DNase- and pyrogen-free.

### Sterile Microcentrifuge Tubes in Assorted Colors - 1.5mL

Part No.	Description	Pack Qty.	Price
CLS-4300-C-001	Inner bags of 50 tubes each, 10 bags per pack (2 bags of each color)	500	\$21.25 ◇

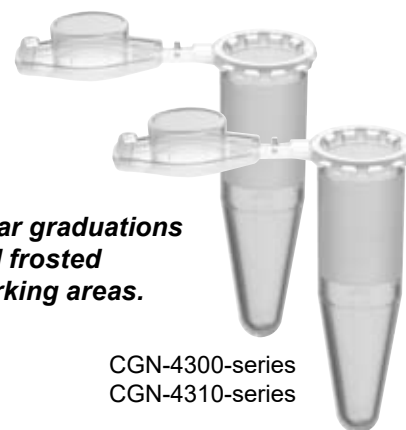

Clear graduations and frosted marking areas.

CGN-4300-series  
CGN-4310-series

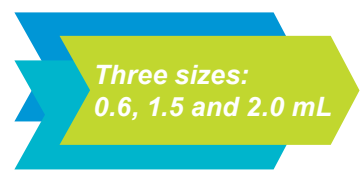

Three sizes: 0.6, 1.5 and 2.0 mL

Tubes graduated at 0.1, 0.5, 1.0 and 1.5mL.



CLS-4300-C-001



CLS-4300-C-001

† Reusable Glass / Plastics Prod. Line ♣ Consumable Prod. Line Ω EDU / Economical Pkg. Prod. Line



CGN-4303-015



CGN-4303-050

### Standard Centrifuge Tubes, 15 and 50mL, Sterile, NEST

- Easy to see black graduation scale
- Large white writing area on tubes
- Polypropylene tubes with polyethylene caps
- Raw materials comply with USP VI requirements
- Flat markable cap with leak-proof seal
- Easy, one-handed, cap operation
- Sterilized by E-Beam, Non-pyrogenic, DNase- and RNase-free
- Max. RCF (xg) 12,000
- Rack packaging is made using environmentally friendly re-usable racks

Available in Bulk Packs and Racks

#### Standard Centrifuge Tubes in Bulk Packs, Sterile

Part No.	Capacity (mL)	Inner Bag Qty.	Pack Qty.	BAGGED	
				Price	SALE Price
CGN-4303-015	15	50	500	<del>\$122.00</del>	\$97.60 ♣
CGN-4303-050	50	25	500	<del>\$167.50</del>	\$134.00 ♣

#### Standard Centrifuge Tubes in PS Racks, Sterile

Part No.	Capacity (mL)	Rack Qty.	Pack Qty.	RACKED	
				Price	SALE Price
CGN-4301-R15	15	50	500	<del>\$130.50</del>	\$104.40 ♣
CGN-4301-R50	50	25	500	<del>\$184.00</del>	\$147.20 ♣



15mL

CGN-4301-R15



50mL

CGN-4301-R50

\* Lab Supply Prod. Line ♦ Life Sciences Consumable Prod. Line

## Individually Wrapped Centrifuge Tubes, 15 and 50mL, Sterile

- Sterile, RNase-, DNase-, pyrogen- and cytotoxin-free
- Frosted marking surface

Conical 15mL and 50mL centrifuge tubes are made of premium polypropylene for clarity and centrifugal strength. Tubes and caps may be frozen at temperatures as low as -86°C. The maximum centrifugal force is 12,000xg for the 15mL tubes and 15,000xg for the 50mL tubes\*. Caps are made of polyethylene and have a flat top surface for easy marking or labeling. Compatible with standard rotors.

\*Refers to liquids with a specific gravity of 1.0, using appropriate rotors, cushions and adapters.

### Individually Wrapped, Polypropylene Centrifuge Tubes, Sterile

Part No.	Capacity (mL)	Dimensions (mm)	Case Qty.	Price
CLS-4303-W-015	15	17 x 118	300	\$117.45 ◇
CLS-4303-W-050	50	29 x 115	300	\$143.00 ◇



CLS-4303-W-050 CLS-4303-W-015  
Compatible with Standard Rotors

## Self-Standing, Polypropylene Centrifuge Tubes, 30mL, Sterile

- Sterile, RNase-, DNase-, pyrogen- and cytotoxin-free
- Compatible with standard rotors
- Frosted marking surface

Conical centrifuge tubes are made of premium polypropylene for clarity and centrifugal strength. Tubes and caps may be frozen at temperatures as low as -86°C. The maximum centrifugal force is 7,000xg. Polyethylene caps have a flat top surface for easy marking and labeling. CLS-4304-030 features a 'skirted' bottom that allow these tubes to stand upright without a separate test tube rack.

### Self-Standing, Polypropylene Centrifuge Tubes, Sterile

Part No.	Capacity (mL)	Dimensions (mm)	Case Qty.	Price
CLS-4304-030	30	29 x 80	500	\$169.05 ◇



CLS-4304-030

## Cell Straining Kits, Sterile, ReadyStrain™

ReadyStrain™ includes all the necessary parts for filtration of cell suspensions in a single, pre-assembled, ready-to-use, sterile packet. Kits eliminate the contamination risks associated with opening multiple packages, and assembling separate pieces (i.e. tubes strainers and caps). Individual sterile packets free researchers from having to expose entire bags of 50mL tubes and caps in order to perform one filtration. Instead, they can open a single ReadyStrain Kit directly under the hood.

Each gamma sterilized kit contains a SureStrain™ Strainer pre-attached to a 50mL tube, with a separate screw-cap ready for assembly, processing and storage after the filtration is complete. Kits supplied in easy open "tear-strip" bags.

### Individually Wrapped, 50mL Cell Straining Kits, ReadyStrain™, Sterile

Part No.	Filter Size (µm)	Strainer Color	Case Qty.	Price
CLS-2007-K-070	70	white	50	\$166.80 ◇
CLS-2007-K-100	100	yellow	50	\$166.80 ◇



CLS-2007-K-100

† Reusable Glass / Plastics Prod. Line ♣ Consumable Prod. Line Ω EDU / Economical Pkg. Prod. Line



CGN-4303-A50

### Amber Centrifuge Tubes in Racks, Sterile , NEST

15mL, and 50mL Tubes

- Meet the requirements of analytical level
- High strength non-toxic materials
- Raw material complies with USP VI requirements
- Printed clear graduations with marking area
- PP for the tube and HDPE for the cap
- One-hand operation design
- Sterilized by E-Beam
- DNase-, RNase- and pyrogen-free
- Maximum centrifugation speed 12,000 x g

### Amber Centrifuge Tubes in PS Racks, Sterile

Part No.	Capacity (mL)	Pack Qty.	Price	SALE Price
CGN-4303-A15	15	50	<del>\$19.00</del>	\$15.20 ♣
CGN-4303-A50	50	25	<del>\$12.50</del>	\$10.00 ♣



CLS-4301-C15



CLS-4301-C50

### Centrifuge Tubes in Foam Racks, Rainbow Caps, Sterile

- Colored caps for easy sample identification
- RNase-, DNase- and Pyrogen-Free

Conical 15 and 50mL, polypropylene centrifuge tube with a proven design. Conveniently configured in a foam rack with five different colored caps for easy sample identification. Tubes are perfect for any lab conducting multiple studies or any experiments requiring multiple sample types or solutions. All five cap varieties are flat, brightly colored, and frosted to make them easy to write on. Tubes have large, rectangular, white marking areas.

Made of premium polypropylene, with exceptionally uniform wall thickness for clarity and centrifugal strength. Tubes and caps may be used for sample storage at temperatures as low as -80°C. The maximum centrifugal forces are 12,000xg for the 15mL tubes and 15,000xg for 50mL version.\*

Tubes and caps are suitable for stem cell research and certified sterile, RNase-, DNase- and Pyrogen-free.

\*Refers to liquids with a specific gravity of 1.0, using appropriate rotors, cushions and adapters.

### Sterile Centrifuge Tubes with Color Caps

Part No.	Capacity (mL)	Qty. / Rack	Qty.	Price
CLS-4301-C15	15	50	500	\$204.05 ◇
CLS-4301-C50	50	25	500	\$216.15 ◇

\* Lab Supply Prod. Line ◇ Life Sciences Consumable Prod. Line

## MacroTube™ Centrifuge Tubes, 5mL, Clear or Black

5mL MacroTubes™ take all of the conveniences of standard 1.5mL tubes and scales them up for larger volumes. Polypropylene tubes come with attached caps that provide tight, leak-proof seals that can also be effortlessly opened and closed with one hand. Caps are designed to provide secure seals from -86°C to +80°C.



**CapLock Clips™** are available to maintain the integrity of the seals at extreme temperatures. In incubated / heated applications, they may be “boiled” for up to 10 minutes. At temperatures above 80°C, the use of the CapLock Clips are recommended.

The center of the cap has a special thin “membrane” (non-resalable) area, designed for easy puncture and access by a syringe / needle. Once punctured, the opening can also be useful for venting the internal pressure caused by incubation at moderately high temperatures.

The potential contamination of pipettor shafts is greatly reduced because the 56mm total tube length (vs. 120mm for standard 15mL centrifuge tubes) is short enough for standard 1mL or 5mL tips to reach the tubes conical bottom.

- Dimensions: 16.5 x 54mm (not including rim and cap)
- Maximum Centrifugal Force: 25,000xg
- RNase- and DNase-free

*The convenience of smaller tubes in a 5mL size!*



CLS-4299-series

### MacroTube™ Centrifuge Tubes

Part No.	Cap. (mL)	Color	Sterility	Bag Qty.	Case Qty.	Price
CLS-4299-05	5	clear	non-sterile	50	200	\$44.50 ◊
CLS-4299-05S	5	clear	sterile	20	200	\$54.00 ◊
CLS-4299-05B	5	black	non-sterile	100	200	\$44.50 ◊

### MacroTube™ Tinted Centrifuge Tubes

Part No.	Cap. (mL)	Color	Sterility	Bag Qty.	Case Qty.	Price
CLS-4299C-05R	5	red	non-sterile	100	200	\$44.50 ◊
CLS-4299C-05B	5	blue	non-sterile	100	200	\$44.50 ◊
CLS-4299C-05G	5	green	non-sterile	100	200	\$44.50 ◊
CLS-4299C-05Y	5	yellow	non-sterile	100	200	\$44.50 ◊
CLS-4299C-05A	5	assorted	non-sterile	50	200	\$44.50 ◊

CLS-4299C-05A contains one bag of each color.



CLS-4299C-series

### CapLock™ Clips with Breakaway Lifting Tabs

Part No.	Case Qty.	Price
CLS-4299-05L	20	\$30.00 ◊



CLS-4299-05L



CLS-4740-005 CLS-4740-010

### Graduated Transport / Mailing Tubes with Screw Caps, Sterile

- Leak-proof, 1.25 turn screw-cap
- Vivid, printed graduations
- Screw-caps attached
- Sterile, RNase-, DNase-, Pyrogen-free

Transport tubes, sometimes called mailing tubes, are used in multiple sectors of the laboratory market, including medical, hospital, environmental, independent testing, food testing, and biological research labs.

Used to store, transport or freeze samples, these tubes come in both 5mL (16 x 60mm) and 10mL (16 x 80mm) and are fitted with leak-proof screw-caps. They are made of high-grade polypropylene, and include white printed graduations and marking area. Tubes are self-standing and come packaged in 10 bags 100 tubes.

### Sterile Transport / Mailing Tubes with Attached Screw Caps

Part No.	Cap. (mL)	Tube Dims. (mm)	Bag Qty.	Pack Qty.	Price
<b>CLS-4740-005</b>	5	16 x 60	100	1000	<b>\$174.00</b> ◇
<b>CLS-4740-010</b>	10	16 x 80	100	1000	<b>\$202.80</b> ◇

### FREE Vornado Miniature Vortex Mixer\*

### Purchase a Roto-Therm Plus Incubated Rotator

**Get a FREE Miniature Vortex Mixer!** (CLS-4886-01)

\* Participation in this offer is limited to purchases made from 1/3/2024 through 12/31/2024 of a Roto-Therm Plus Incubated Rotator, CLS-3969-V-024 from Chemglass Life Sciences. Receive a free Vornado Miniature Vortex Mixer, CLS-4886-01, with purchase. To qualify, purchaser must specify promo code **BM24-4886** with order.

**Valid on US and Canadian purchases only.** May not be combined with any other offer or discount. This offer is non-transferable and void where prohibited by law or company policy. Offer is subject to Chemglass Life Sciences' standard terms, conditions and contracts. **Offer not valid through distributors.**

\* Lab Supply Prod. Line ◇ Life Sciences Consumable Prod. Line

## Flowtubes for Flow Cytometry Instruments, 12 X 75mm, 5mL

- Compatible with FACS (BD) instruments
- Available with 35µm strainer cap, standard cap, or no cap
- Clear polystyrene
- 5mL capacity

Made of crystal-clear polystyrene, these 12 x 75mm FlowTubes™ are designed for Fluorescence Activated Cell Sorting / flow cytometry equipment including FACS systems from BD Biosciences.

The diameter and wall thickness of the tube's neck is held to very tight tolerances to ensure consistent compatibility with the automated instrument. They are available with the standard two-position culture cap, no cap at all, or with a cap that contains a 35µm nylon mesh screen, designed to assist in cell sorting / straining applications. These tubes are primarily used to collect dissociated sample for subsequent processing in automated flow cytometry instruments.

### FlowTubes with Strainer Caps, Sterile

Part No.	Dims. (mm)	Pack Configuration	Case Qty.	Price
CLS-4380-005	12 x 75	25 / Bag	500	\$502.90 ◇
CLS-4380-007	12 x 75	Individually Wrapped	500	\$571.30 ◇

### FlowTubes with Standard Caps, Sterile

Part No.	Dims. (mm)	Pack Configuration	Case Qty.	Price
CLS-4380-014	12 x 75	250 per Tray Box	1000	\$144.50 ◇

### FlowTubes Only (without Caps)

Part No.	Description	Dims. (mm)	Pack Configuration	Case Qty.	Price
CLS-4380-010	Sterile	12 x 75	25 / Bag	500	\$118.65 ◇
CLS-4380-020	Non-Sterile	12 x 75	Bulk Econo-Pack	4000	\$259.00 ◇

### FlowTube Caps

Part No.	Description	Inner Qty.	Case Qty.	Price
CLS-4380-009	Strainer Caps, 35µm Mesh, Sterile	25 / Bag	500	\$200.25 ◇
CLS-4380-019	Standard Caps, Non-Sterile	125 / Bag	1000	\$82.80 ◇



CLS-4380 Tubes with Strainer Caps



CLS-4380-007



CLS-4380-009 Strainer Cap



CLS-4380 Tubes with Standard Caps



CLS-4380-020 Bulk Econo-Pack

† Reusable Glass / Plastics Prod. Line ♣ Consumable Prod. Line Ω EDU / Economical Pkg. Prod. Line



customer-service@cglifesciences.com  
tech@cglifesciences.com

T 1.800.843.1794 F 1.800.922.4361

Chemistry | Life Sciences | Reactors | Vials  
More than 12,000 products online.

[www.cglifesciences.com](http://www.cglifesciences.com)

**SPECIAL  
OFFERS**



**FREE 100g Bottle of Agarose with a 500g agarose purchase.**

See page 17.



**Get two Mini Centrifuges for only \$250!**

See page 23.



**FREE Compact Balance with ACCURIS Balance purchase.**

See page 3.



**FREE Block with Multi-Therm Temperature Controlled Vortexing Shakers.**

See page 18.



**FREE Mini Centrifuge with MC-24 Touch, High Speed Microcentrifuge purchase.**

See page 21.



**AccuPet Pro Micropipettes - Buy Two Get Third FREE**

See page 48.



**FREE Vornado Miniature Vortex Mixer with Roto-Therm Plus Incubated Rotator purchase.**

See page 70.

**Plus sale prices on many products throughout the catalog.**